

Register your instrument!
www.eppendorf.com/myeppendorf



Eppendorf ThermoMixer® F0.5/F1.5/F2.0/FP

Operating Manual

Copyright ©2021 Eppendorf AG, Germany. All rights reserved, including graphics and images. No part of this publication may be reproduced without the prior permission of the copyright owner.

Eppendorf® and the Eppendorf Brand Design are registered trademarks of Eppendorf SE, Germany.

Eppendorf ThermoMixer®, Eppendorf ThermoTop®, and *condens.protect*® are registered trademarks of Eppendorf AG, Germany.

Registered trademarks and protected trademarks are not marked in all cases with ® or ™ in this manual.

U.S. Patents are listed on www.eppendorf.com/ip

Table of contents

1	Operating instructions	5
1.1	Using this manual	5
1.2	Danger symbols and danger levels	5
1.2.1	Danger symbols	5
1.2.2	Danger levels	5
1.3	Symbols used	6
2	Safety	7
2.1	Intended use	7
2.2	User profile	7
2.3	Information on product liability	7
2.4	Warnings for intended use	8
2.5	Danger symbols on the device	10
3	Product description	11
3.1	Delivery package	11
3.1.1	ThermoMixer F0.5, ThermoMixer F1.5, ThermoMixer F2.0	11
3.1.2	ThermoMixer FP	11
3.2	Product overview	12
3.3	Features	14
4	Installation	15
4.1	Selecting the location	15
4.2	Installing the instrument	15
5	Operation	16
5.1	Operating controls	16
5.2	Inserting tubes and plates	17
5.2.1	Inserting tubes	17
5.2.2	Inserting the plate	18
5.3	Controlling the thermoblock temperature	18
5.3.1	Temperature control without mixing process	19
5.4	Mixing	19
5.4.1	Mixing without temperature control	20
5.4.2	Mixing and temperature control	20
5.4.3	Short Mix	20
5.5	Menu	21
5.5.1	Navigate the menu	21
5.5.2	Menu structure	21
5.6	Loading saved parameters	22
6	Software	23
6.1	Performing a software update	23

4 Table of contents
Eppendorf ThermoMixer® F0.5/F1.5/F2.0/FP
English (EN)

7	Troubleshooting	24
7.1	General errors	24
7.2	Error messages	25
8	Maintenance	26
8.1	Setting a service interval	26
8.2	Cleaning	26
8.2.1	Cleaning the Eppendorf ThermoMixer F0.5/F1.5/F2.0/FP	27
8.3	Disinfection/Decontamination	27
8.4	Decontamination before shipment	28
8.5	Verification of temperature control	28
9	Transport, storage and disposal	29
9.1	Transport	29
9.2	Storage	29
9.3	Disposal	30
10	Technical data	31
10.1	Power supply	31
10.2	Weight/dimensions	31
10.3	Ambient conditions	31
10.4	Application parameters	32
10.4.1	Temperature control	32
10.4.2	Mixing	33
10.5	Interface	33
	Certificates	35

1 Operating instructions









1.1 Using this manual

- ▶ Read this operating manual completely before using the device for the first time. Observe the instructions for use of the accessories where applicable.
- ▶ This operating manual is part of the product. Please keep it in a place that is easily accessible.
- ▶ Enclose this operating manual when transferring the device to third parties.
- ▶ The current version of the operating manual for all available languages can be found on our webpage www.eppendorf.com/manuals.

1.2 Danger symbols and danger levels

1.2.1 Danger symbols

The safety instructions in this manual have the following danger symbols and danger levels:

	Biohazard		Explosive substances
	Electric shock		Hot surfaces
	Hazard point		Highly flammable substances
	Risk of crushing		Material damage

1.2.2 Danger levels

DANGER	<i>Will</i> lead to severe injuries or death.
WARNING	<i>May</i> lead to severe injuries or death.
CAUTION	May lead to light to moderate injuries.
NOTICE	May lead to material damage.

1.3 Symbols used

Depiction	Meaning
1. 2.	Actions in the specified order
▶	Actions without a specified order
•	List
<i>Text</i>	Display or software texts
	Additional information

2 Safety

2.1 Intended use

The Eppendorf ThermoMixer F0.5/F1.5/F2.0/FP is designed for the temperature control and mixing of liquids in closed tubes and closed plates for the preparation and processing of samples.

The Eppendorf ThermoMixer F0.5/F1.5/F2.0/FP is exclusively intended for indoor use. All country-specific safety requirements for operating electrical equipment in laboratories must be observed.

Only use Eppendorf accessories or accessories recommended by Eppendorf.

The product can be used for training, routine and research laboratories in the areas of life sciences, industry or chemistry. This product is intended to be used for research purposes only. Eppendorf does not provide a warranty for other applications. The product is not suitable for use in diagnostic or therapeutic applications.

2.2 User profile

The device and accessories may only be operated by trained and skilled personnel.

Before using the device, read the operating manual and the instructions for use of the accessories carefully and familiarize yourself with the device's mode of operation.

2.3 Information on product liability

In the following cases, the designated protection of the device may be affected. The liability for any resulting damage or personal injury is then transferred to the owner:

- The device is not used in accordance with the operating manual.
- The device is used outside of its intended use.
- The device is used with accessories or consumables that are not recommended by Eppendorf.
- The device is maintained or repaired by persons not authorized by Eppendorf AG.
- The user makes unauthorized changes to the device.

2.4 Warnings for intended use

Read the operating manual and observe the following general safety information before using the Eppendorf ThermoMixer F0.5/F1.5/F2.0/FP.



WARNING! Electric shock due to damage to the device or the mains/power cord.

- ▶ Only switch on the device if the device and the mains/power cord are undamaged.
- ▶ Only operate devices which have been installed or repaired properly.
- ▶ In the event of danger, disconnect the device from the mains/power supply voltage. Disconnect the mains/power plug from the device or the earth/grounded socket. Use the isolating device intended for this purpose (e.g., the emergency switch in the laboratory).



WARNING! Risk of burns from hot surfaces.

The thermoblock can be very hot after heating and cause burns.

- ▶ Avoid direct contact with a heated thermoblock.



WARNING! Damage to health due to infectious liquids and pathogenic germs.

- ▶ When handling infectious liquids and pathogenic germs, observe the national regulations, the biosafety level of your laboratory, and the manufacturers' Safety Data Sheets and application notes.
- ▶ Wear your personal protective equipment.
- ▶ For comprehensive regulations about handling germs or biological material of risk group II or higher, please refer to the "Laboratory Biosafety Manual" (source: World Health Organization, Laboratory Biosafety Manual, in the currently valid version).



WARNING! Risk of fire.

- ▶ Do not use this device to process any highly flammable liquids.



WARNING! Contamination due to opening seals of consumables.

In the following cases, the seals of micro test tubes or plates can spring open. Sample material can escape.

- High vapor pressure of the content
 - Improperly sealed lid
 - Damaged sealing lip
 - Improperly fastened foil
- ▶ Always check that consumables have been sealed tightly before use.



WARNING! Injury from sample material being thrown out.

Sample material can be thrown out of open, improperly sealed or unstable tubes and plates.

- ▶ Only mix in closed tubes and closed plates.
- ▶ Observe the nationally prescribed safety environment when working with hazardous, toxic and pathogenic samples. Pay particular attention to personal protective equipment (gloves, clothing, goggles, etc.), extraction, and the biosafety level of the lab.



CAUTION! Poor safety due to incorrect accessories and spare parts.

The use of accessories and spare parts other than those recommended by Eppendorf may impair the safety, functioning and precision of the device. Eppendorf cannot be held liable or accept any liability for damage resulting from the use of accessories and spare parts other than those recommended or from improper use.

- ▶ Only use accessories and original spare parts recommended by Eppendorf.



CAUTION! Risk of crushing form movable parts.

- ▶ Do not replace any consumables during the mixing process.
- ▶ Do not remove the Transfer Rack during the mixing process.
- ▶ Put on the ThermoTop or Lid prior to the mixing process.
- ▶ Do not remove the ThermoTop or Lid during the mixing process.



NOTICE! Damage due to strong vibrations.

When mixing at high speeds, items located near the device may be moved by the vibrations of the work surface and, e.g., fall off the work table.

- ▶ Do not place easily movable items near the device or secure them adequately.



NOTICE! Damage to the display due to mechanical pressure.

- ▶ Do not apply any mechanical pressure to the display.



NOTICE! Damage from overheating.

- ▶ Do not install the device near heat sources (e.g., heaters, drying cabinets).
- ▶ Do not expose the device to direct sunlight.
- ▶ Ensure unobstructed air circulation. Maintain a clearance of at least 10 cm around all ventilation gaps.

2.5 Danger symbols on the device

Depiction	Meaning	Location
	Risk of burns from hot surfaces.	On the thermoblock
	Hazard point ▶ Observe the operating manual.	<ul style="list-style-type: none">• Rear of the device• On the thermoblock

3 Product description

3.1 Delivery package

3.1.1 ThermoMixer F0.5, ThermoMixer F1.5, ThermoMixer F2.0

Quantity	Description
1	ThermoMixer
1	Mains/power cord
1	Operating manual
1	TransferRack with lid and instructions for use

3.1.2 ThermoMixer FP

Quantity	Description
1	ThermoMixer
1	Lid
1	Mains/power cord
1	Operating manual



- ▶ Check that the delivery is complete.
- ▶ Check all parts for transport damage.
- ▶ To safely transport and store the device, retain the transport box and packing material.

3.2 Product overview

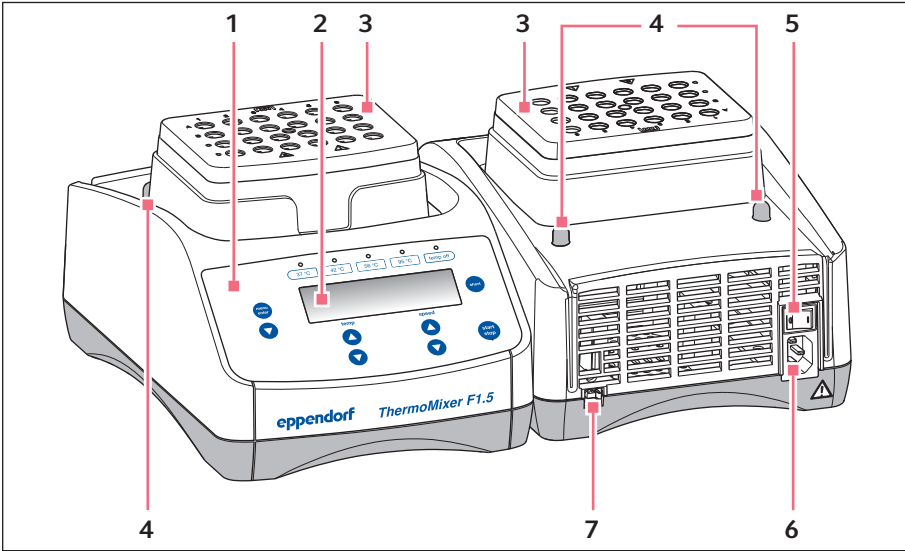

Fig. 3-1: ThermoMixer F1.5 (ThermoMixer F0.5 and ThermoMixer F2.0 similar)

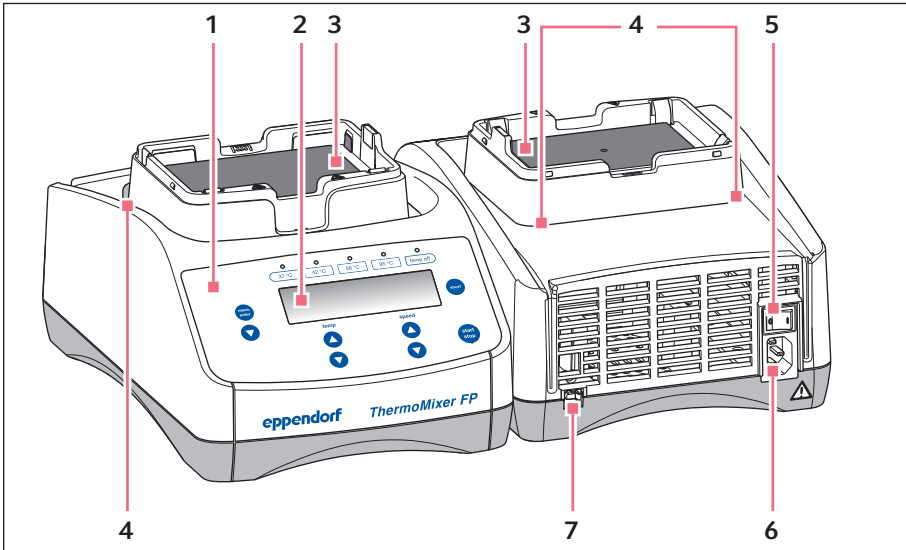

Fig. 3-2: ThermoMixer FP

- | | | | |
|---|--------------------|---|---|
| 1 | Operating controls | 5 | Mains/power switch |
| 2 | Display | 6 | Mains/power cord socket |
| 3 | Thermoblock | 7 | USB interface for connecting to Visionize |
| 4 | Centering pins | | |

Product description

Eppendorf ThermoMixer® F0.5/F1.5/F2.0/FP
English (EN)

3.3 Features

You can use the Eppendorf ThermoMixer F0.5/F1.5/F2.0/FP to perform two basic applications of sample preparation in one convenient step: The simultaneous mixing and temperature control of the sample material.

- Eppendorf ThermoMixer F0.5: for 24 0.5 mL micro test tubes (e.g., Eppendorf Safe-Lock Tubes)
- Eppendorf ThermoMixer F1.5: for 24 1.5 mL micro test tubes (e.g., Eppendorf Safe-Lock Tubes)
- Eppendorf ThermoMixer F2.0: for 24 2.0 mL micro test tubes (e.g., Eppendorf Safe-Lock Tubes)
- Eppendorf ThermoMixer FP: all common plate formats (e.g., Eppendorf Microplates or Eppendorf Deepwell Plates).

Temperature control

- Temperatures from 4 °C above ambient temperature to 100 °C are maintained exactly and constantly.
- The temperatures 37 °C, 42 °C, 56 °C, 95 °C can be selected directly.

Mixing

- Anti-spill technology prevents lid wetting and cross contamination.
- Eppendorf ThermoMixer F1.5, Eppendorf ThermoMixer F2.0: You can select a mixing frequency between 300 rpm and 1 500 rpm.
- Eppendorf ThermoMixer F0.5, Eppendorf ThermoMixer FP: You can select a mixing frequency between 300 rpm and 2 000 rpm.
- The controlled and efficient mixing movement of the ^{2D}Mix-Control technology provides for a fast and complete mixing even of minimum volumes.
- **Short Mix:** Short, uncomplicated mixing of sample material. The mixing process is performed at the selected speed as long as you press the **short** key.

Lid and ThermoTop

- The Lid ensures uniform temperature control and protects samples from unwanted exposure to light.
- The ThermoTop prevents the formation of condensation on the inner wall or the lid of the tube thanks to the *condens.protect* technology.

SmartExtender

- The SmartExtender heats up lab vessels, independently from the SmartBlock, in a second temperature zone.

4 Installation

4.1 Selecting the location

Select the location of the device according to the following criteria:

- Mains/power connection in accordance with the name plate
 - Minimum distance to other devices and walls: 10 cm
 - Resonance free table with horizontal even work surface
 - The location must be well ventilated
 - The location is protected against direct sunlight
-  The mains/power switch and the disconnecting device of the mains/power line must be accessible during operation (e.g., residual current circuit breaker).

4.2 Installing the instrument



WARNING! Danger due to incorrect voltage supply.

- ▶ Only connect the device to voltage sources which correspond with the electrical requirements specified on the name plate.
 - ▶ Only use earth/grounded sockets with a protective earth conductor.
 - ▶ Only use the mains/power cord supplied.
-

1. Place the Eppendorf ThermoMixer F0.5/F1.5/F2.0/FP on a suitable work surface. Position the device in such a way that the ventilation slots of the device are not obstructed.
2. Connect the power cable to the power connection socket of the device and the power supply.

5

Operation

5.1

Operating controls

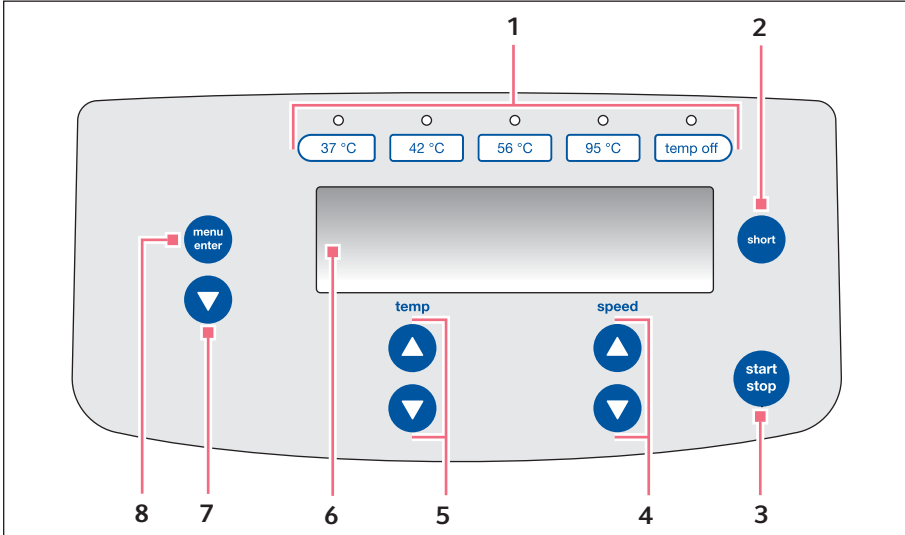

Fig. 5-1: Eppendorf ThermoMixer F0.5/F1.5/F2.0/FP operating controls

- | | |
|---|---|
| 1 Temperature keys with control LEDs | 5 temp arrow keys
Setting the temperature |
| 2 short key
Short Mix will run as long as the short key is pressed. | 6 Display |
| 3 start/stop key
Pressing the start/stop key: start or stop mixing/temperature control | 7 Menu arrow key
Navigating in the menu |
| 4 speed arrow keys
Setting the mixing frequency | 8 menu/enter key
Open the menu
Confirm selection |

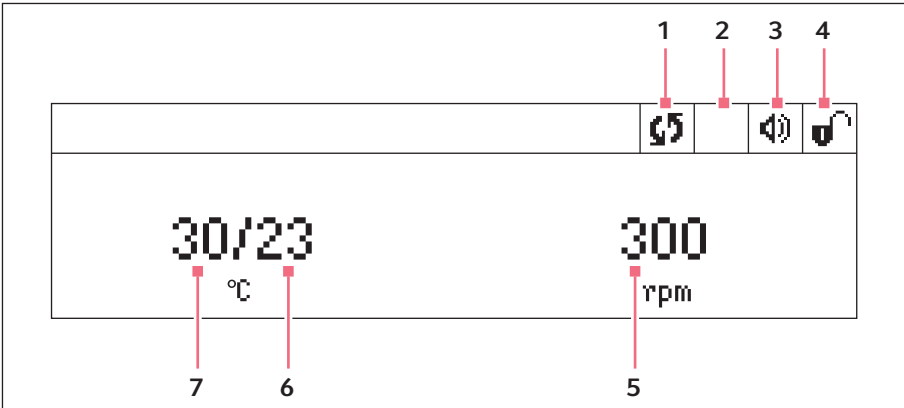

Fig. 5-2: Eppendorf ThermoMixer F0.5/F1.5/F2.0/FP display

1 Device status

☞ Device is performing mixing/temperature control.

2 ThermoTop

☞ ThermoTop has been attached.
 ☞ SmartExtender is attached.

3 Speaker

☞ Speaker switched on.
 ✖ Speaker switched off.

4 Key lock

☞ Key lock is activated: parameters cannot be changed.
 ☞ No key lock.

5 Mixing frequency

6 Actual temperature

7 Set temperature

When the set temperature has been reached, only one value is displayed.

5.2 Inserting tubes and plates

5.2.1 Inserting tubes

- ▶ Only use closed tubes.
- ▶ Insert the tubes completely into the bores of the thermoblock.

5.2.2 Inserting the plate



The height sensor of the Eppendorf ThermoMixer FP automatically differentiates between deepwell plates and microplates.

- ▶ When inserting microplates, make sure that the height sensor is not covered.
- ▶ Take care that the height sensor does not get contaminated.

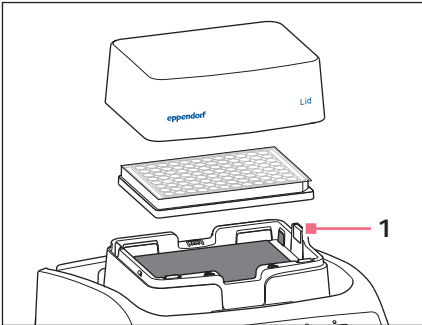

- ▶ Only use closed plates.
- ▶ Insert the plate with the back edge first. Then press it down at the front.
- ▶ To ensure uniform temperature control in all wells, place the lid on the thermoblock.

Fig. 5-3: 1 – Eppendorf ThermoMixer FP height sensor

5.3 Controlling the thermoblock temperature



NOTICE! Damage to electronic components due to condensation.

Condensate may form in the device when it has been transported from a cool environment to a warmer environment.

- ▶ After installing the device, wait for at least 3 h. Only then connect the device to the mains/power line.



NOTICE! Damaged plates due to temperatures that are too high.

Polystyrene microplates melt at temperatures above 70 °C.

Polypropylene deepwell plates deform at temperatures above 80 °C. Deformed plates may become detached from the thermoblock or are more difficult to remove.

- ▶ Temper polystyrene microplates up to 70 °C max.
- ▶ If you are heating deepwell plates above 80 °C, do not exceed the mixing frequency of 1000 rpm.



NOTICE! Change in the material of consumables at extreme temperatures.

Extreme temperatures (e.g., during freezing or autoclaving) affect materials. The mechanical strength, dimensions and shape of the consumable will change.

- ▶ Use consumables that are suitable for the selected temperature range and the selected procedure.

The Eppendorf ThermoMixer F0.5/F1.5/F2.0/FP can control temperature in a range from 4 °C above ambient temperature to 100 °C.

- When the actual temperature flashes on the display, the device is not in temperature control mode operation.
- As soon as the set temperature is modified with the **temp** arrow keys, the device will start temperature control.
- When the set temperature has been reached, the display only shows a value.

5.3.1 Temperature control without mixing process

1. To switch off the mixing function, select the 0 rpm setting with the **speed** arrow keys (▼ before 300 rpm or ▲ after 1 500 rpm or 2 000 rpm).

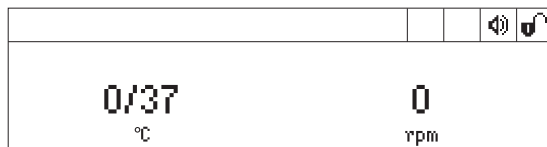

2. Set the temperature with the **temp** arrow keys.
 - The device immediately starts temperature control.
 - When the set temperature is not changed, the actual temperature flashes on the display and the device does not perform temperature control.
3. To start the temperature control process manually, press the **start/stop** key.
 - The  symbol flashes on the display.
 - The display shows the actual temperature/set temperature.

5.4 Mixing

- The mixing frequency can be set in increments of 50 rpm.
 - Eppendorf ThermoMixer F0.5: 300 rpm – 2 000 rpm
 - Eppendorf ThermoMixer F1.5: 300 rpm – 1 500 rpm
 - Eppendorf ThermoMixer F2.0: 300 rpm – 1 500 rpm
 - Eppendorf ThermoMixer FP: 300 rpm – 2 000 rpm

Operation

Eppendorf ThermoMixer® F0.5/F1.5/F2.0/FP
English (EN)

5.4.1 Mixing without temperature control

1. To switch off temperature control, press the **temp off** key.



2. Set the mixing frequency with the **speed** arrow keys.
3. To start the mixing process, press the **start/stop** key.
 - The  symbol flashes on the display.
4. To end the mixing process, press the **start/stop** key.
 - The display shows the last used parameters.

5.4.2 Mixing and temperature control

1. Set the temperature with the **temp** arrow keys.
The device immediately starts temperature control.
2. Set the mixing frequency with the **speed** arrow keys.



3. To start the mixing process, press the **start/stop** key.
 - The  symbol flashes on the display.
 - The display shows the actual temperature/set temperature and the mixing frequency.
4. To end the mixing process, press the **start/stop** key.
 - The display shows the last used parameters.
 - Temperature control is continued.

5.4.3 Short Mix





Use the Short Mix function for short mixing times without temperature control.

1. Set the mixing frequency with the **speed** arrow keys.
2. Keep the **short** key pressed.
The mixing process will run as long as the **short** key is pressed.
3. To end Short Mix, release the **short** key.





5.5 Menu

5.5.1 Navigate the menu

To change settings, proceed as follows:

1.		In order to open the menu, keep the menu/enter key pressed.
2.		Select the menu item with the menu arrow key.
3.		To confirm your selection, press the menu/enter key.
4.		Change the settings with the menu arrow key.
5.		To confirm the changed setting, press the menu/enter key. A tick appears in front of the setting.
6.		To exit the menu level, select <i>Back</i> in the menu and press the menu/enter key.

5.5.2 Menu structure

Menu items and options	Description	Symbol on the display
Key lock (<i>Key lock</i>) <ul style="list-style-type: none"> • <i>Key lock on</i> • <i>Key lock off</i> 	<ul style="list-style-type: none"> • Parameters cannot be changed. • Parameters can be changed. 	 
Volume (<i>Volume</i>)	<p>The signal tone for error messages is always output at medium volume level regardless of the speaker settings.</p> <ul style="list-style-type: none"> • Set the volume of the speaker: <i>Volume 1, Volume 2, Volume 3</i> • Switching the speaker off: <i>Volume off</i> 	 
Contrast (<i>Contrast</i>)	<ul style="list-style-type: none"> • Set the contrast: <i>0 %, 25 %, 50 %, 75 %, 100 %</i> 	
Service (<i>Service</i>)	<ul style="list-style-type: none"> • Set the service interval: <i>After 500 operating hours</i> <i>After 1000 operating hours</i> <i>After 2000 operating hours</i> <i>No notification</i> 	

Operation

Eppendorf ThermoMixer® F0.5/F1.5/F2.0/FP
English (EN)

Back: Go to next higher menu level.

5.6 Loading saved parameters

The **37 °C** to **95 °C** keys can be used to quickly select a temperature for a temperature control procedure for an unlimited period of time. Use the **temp off** key to switch off temperature control.

	Temperature	Mixing frequency
Key 37 °C	37 °C	<i>off</i>
Key 42 °C	42 °C	<i>off</i>
Key 56 °C	56 °C	<i>off</i>
Key 95 °C	95 °C	<i>off</i>
Key temp off	<i>off</i>	<i>off</i>

- ▶ To call a saved temperature, press a direct selection key (**37 °C** to **95 °C**).
 - The LED above the key lights blue.
 - The display shows saved parameters.
 - ▶ To start temperature control, press the **start/stop** key.
 - ▶ To perform temperature control and mixing at the same time, also set the mixing frequency using the **speed** arrow keys.
-  To exit the displayed parameters, set different values for the temperature or mixing frequency.

6 Software

6.1 Performing a software update

Prerequisites

- Computer with Windows 7 or Windows 10
Administrator rights are not necessary.
 - VisioNize box adapter cable
Alternative: A shielded USB 2.0 high speed cable plug A to plug B
1. Switch on the device. Read the installed software version on the display.
The installed software version appears on the display during the start-up process.
 2. If the installed software version is older than the latest software version, perform an update.
 3. Download the software as a ZIP file from the webpage <https://www.eppendorf.com/software-downloads/>.
 4. Open the ZIP file.
 5. Connect the device to the computer with the USB cable.
 6. Switch on the device.
 7. Start the "Eppendorf_ThermoMixer_Autoupdate.exe" program with a double click.
 8. When prompted by the program, allow the software update to be performed.
The software update starts immediately.
 9. Wait until the prompt to close the window appears.
Do not interrupt the update process.
After the software update, the program will ask whether other devices should be updated.
 10. If there are no other devices to be updated, answer no to the prompt.
 11. If the software for another device needs to be updated, connect a new device.
 12. Confirm the prompt.
The update process is repeated.

7 Troubleshooting

If you cannot remedy an error with the recommended measures, please contact your local Eppendorf partner. The contact address can be found on the Internet at www.eppendorf.com.

7.1 General errors

Problem	Cause	Solution
Display remains dark.	No mains/power connection.	<ul style="list-style-type: none"> ▶ Check the mains connection and the power supply. ▶ Switch on the device.
Set temperature is not reached.	Set temperature is less than 4 °C above ambient temperature.	<ul style="list-style-type: none"> ▶ Set up the device in a cooler environment.
ThermoTop LED does not light.	The interface between the device and the ThermoTop is dirty.	<ul style="list-style-type: none"> ▶ Remove any dirt from the front of the ThermoTop. ▶ Remove any dirt from the top of the device, especially from the viewing window in front of the thermoblock.
ThermoTop does not fit on the device.	<ul style="list-style-type: none"> • The lid is attached to the thermoblock. • TransferRack is attached. • SmartExtender is attached. 	<ul style="list-style-type: none"> ▶ If using the ThermoTop, do not use the lid. ▶ Remove the TransferRack when using the ThermoTop. ▶ Remove the SmartExtender when using the ThermoTop.
The device does not mix or control the temperature.	Various causes are possible.	<ul style="list-style-type: none"> ▶ Contact your local Eppendorf partner.

7.2 Error messages

Problem	Cause	Solution
Error message preceded by a number code.	Various causes are possible.	<ol style="list-style-type: none"> 1. Switch off the device and wait 10 seconds. 2. Switch on the device. If the error message appears again, contact your local Eppendorf partner.
SmartExtender is not detected by the device.	<ul style="list-style-type: none"> • The Eppendorf ThermoMixer® requires software version 3.0.0 or higher to detect the SmartExtender. 	<ul style="list-style-type: none"> ▶ Perform a software update. The software can be downloaded from the Eppendorf website.

8 Maintenance

8.1 Setting a service interval

The Eppendorf ThermoMixer F0.5/F1.5/F2.0/FP offers the option of setting a service reminder for the device. To set a service interval, proceed as follows:

1. Under *Menu > Settings* select the *Service* menu item. Confirm with the **menu/enter** key.
2. Select the service interval with the menu arrow keys (after 500, 1 000 or 2 000 operating hours).

To turn off the notification, select *No notification*.

A message will appear when the selected operating hours have been reached. Contact your local Eppendorf partner. You can find the contact addresses on the Internet at www.eppendorf.com/worldwide.

8.2 Cleaning



DANGER! Electric shock due to the ingress of liquid.

- ▶ Switch off the device and disconnect it from the mains/power line before commencing any cleaning or disinfection procedures.
 - ▶ Do not allow any liquids to enter the inside of the housing.
 - ▶ Use sealed vessels and sealed plates.
 - ▶ Do not spray clean or spray disinfect the housing.
 - ▶ Only reconnect the device to the mains/power line when it is completely dry, both inside and outside.
-



NOTICE! Damage due to aggressive chemicals.

- ▶ Do not use any aggressive chemicals on the device or its accessories, such as strong and weak bases, strong acids, acetone, formaldehyde, halogenated hydrocarbons or phenol.
- ▶ If the device has been contaminated by aggressive chemicals, clean it immediately using a mild cleaning agent.



NOTICE! Corrosion due to aggressive cleaning agents and disinfectants.

- ▶ Do not use any corrosive cleaning agents, aggressive solvents or abrasive polishes.
 - ▶ Do not use any laboratory cleaners with sodium hypochlorite.
-

- ▶ Clean the housing of the Eppendorf ThermoMixer F0.5/F1.5/F2.0/FP regularly.

8.2.1 Cleaning the Eppendorf ThermoMixer F0.5/F1.5/F2.0/FP

Auxiliary equipment

- Lint-free cloth.
 - Mild, soap-based lab cleaner.
 - Dist. water
1. Switch off the Eppendorf ThermoMixer F0.5/F1.5/F2.0/FP and disconnect it from the power supply.
 2. Allow the device to cool down.
 3. Clean all external parts of the Eppendorf ThermoMixer F0.5/F1.5/F2.0/FP with a mild soap solution and a lint-free cloth.
 4. Wipe off the soap solution with dist. water.
 5. Dry all cleaned parts.

8.3 Disinfection/Decontamination



DANGER! Electric shock due to the ingress of liquid.

- ▶ Switch off the device and disconnect it from the mains/power line before commencing any cleaning or disinfection procedures.
 - ▶ Do not allow any liquids to enter the inside of the housing.
 - ▶ Use sealed vessels and sealed plates.
 - ▶ Do not spray clean or spray disinfect the housing.
 - ▶ Only reconnect the device to the mains/power line when it is completely dry, both inside and outside.
-

Auxiliary equipment

- Lint-free cloth.
 - Disinfectant.
1. Switch off the Eppendorf ThermoMixer F0.5/F1.5/F2.0/FP and disconnect it from the mains/power supply.
 2. Allow the device to cool down.
 3. Clean the device .
 4. Select a disinfection method that complies with the legal requirements and regulations in place for your range of application.
 5. Wipe the surfaces with the lint-free cloth and disinfectant.

8.4 Decontamination before shipment

If you are shipping the device to the authorized Technical Service for repairs or to your authorized dealer for disposal please note the following:



WARNING! Risk to health from contaminated device.

1. Observe the information in the decontamination certificate. It is available as a PDF document on our webpage (<https://www.eppendorf.com/decontamination>).
 2. Decontaminate all the parts to be shipped.
 3. Include the fully completed decontamination certificate in the shipment.
-

8.5 Verification of temperature control

To verify the temperature accuracy of the thermoblock, use the Eppendorf Temperature Verification System – Single Channel. In combination with the temperature sensor for the Eppendorf ThermoMixer F0.5/F1.5/F2.0/FP the exact temperature in the thermoblock can be measured.

Details on the verification process with the Eppendorf Temperature Verification System – Single Channel can be found in the corresponding operating manual.

9 Transport, storage and disposal
9.1 Transport



CAUTION! Risk of injury due to lifting and carrying heavy loads.

The device is heavy. Lifting and carrying the device can lead to back injuries.

- ▶ Transport and lift the device with an adequate number of helpers.
- ▶ Use a transport aid to transport the device.

- ▶ Use the original packaging and the transport securing devices for transport.

	Air temperature	Relative humidity	Atmospheric pressure
General transport	-25 °C – 60 °C	10 % – 75 %	30 kPa – 106 kPa
Air freight	-40 °C – 55 °C	10 % – 75 %	30 kPa – 106 kPa

9.2 Storage

	Air temperature	Relative humidity	Atmospheric pressure
In transport packing	-25 °C – 55 °C	10 % – 95 %	70 kPa – 106 kPa
Without transport packing	-5 °C – 45 °C	10 % – 95 %	70 kPa – 106 kPa

9.3 Disposal

Observe the relevant legal regulations when disposing of the product.

Information on the disposal of electrical and electronic devices in the European Community:

Within the European Community, the disposal of electrical devices is regulated by national regulations based on EU Directive 2012/19/EU pertaining to waste electrical and electronic equipment (WEEE).

According to these regulations, any devices supplied after August 13, 2005, in the business-to-business sphere, to which this product is assigned, may no longer be disposed of in municipal or domestic waste. They are marked with the following symbol to indicate this:

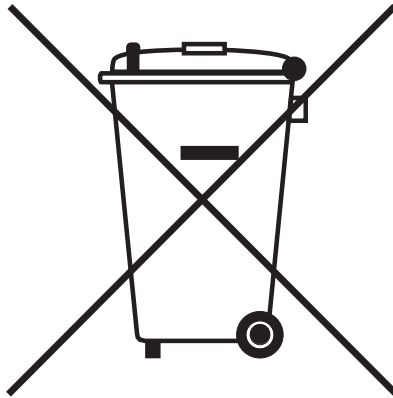

As the disposal regulations may differ from one country to another within the EU, please contact your supplier for more information.

10 Technical data

10.1 Power supply

Power connection	100 V – 130 V \pm 10 %, 50 Hz – 60 Hz 220 V – 240 V \pm 10 %, 50 Hz – 60 Hz
Power consumption	Maximum 200 W
Overvoltage category	II
Degree of pollution	2
Protection class	I

10.2 Weight/dimensions

Width		20.6 cm (8.1 in)
Depth		30.4 cm (12.0 in)
Height	Eppendorf ThermoMixer F0.5	16.3 cm (6.4 in)
	Eppendorf ThermoMixer F1.5	17.0 cm (6.7 in)
	Eppendorf ThermoMixer F2.0	17.0 cm (6.7 in)
	Eppendorf ThermoMixer FP	16.4 cm (6.5 in)
Weight	Eppendorf ThermoMixer F0.5	6.2 kg (13.7 lb)
	Eppendorf ThermoMixer F1.5	6.3 kg (13.9 lb)
	Eppendorf ThermoMixer F2.0	6.3 kg (13.9 lb)
	Eppendorf ThermoMixer FP	6.1 kg (13.4 lb)

10.3 Ambient conditions

Environment	For indoor use only
Ambient temperature	5 °C – 40 °C
Relative humidity	10 % – 90 %, non-condensing
Atmospheric pressure	79.5 kPa – 106 kPa

Technical data

Eppendorf ThermoMixer® F0.5/F1.5/F2.0/FP
English (EN)

10.4 Application parameters**10.4.1 Temperature control**

Temperature control range	1 °C – 100 °C, can be set in increments of 1 °C Minimum: 4 °C above the ambient temperature Maximum: 100 °C	
Temperature accuracy	Set temperature 20 °C – 45 °C	Set temperature < 20 °C or > 45 °C
Eppendorf ThermoMixer F0.5	±0.5 °C	±0.5 °C
Eppendorf ThermoMixer F1.5	±0.5 °C	±0.5 °C
Eppendorf ThermoMixer F2.0	±0.5 °C	±0.5 °C
Eppendorf ThermoMixer FP	±1.0 °C	±4.0 °C
Temperature homogeneity in relation to all positions of the thermoblock	Set temperature 20 °C – 45 °C	Set temperature < 20 °C or > 45 °C
Eppendorf ThermoMixer F0.5/F1.5/F2.0/FP	±0.5 °C	±1.5 °C
Heating rate	The change of temperature in filled tubes is slower.	
Eppendorf ThermoMixer F0.5	15 °C/min	
Eppendorf ThermoMixer F1.5	11 °C/min	
Eppendorf ThermoMixer F2.0	13 °C/min	
Eppendorf ThermoMixer FP	18 °C/min	



The heating and cooling rates refer exclusively to the thermoblock and can change with the filling volume in the tubes.

10.4.2 Mixing

Mixing frequency can be set in increments of 50 rpm

Eppendorf ThermoMixer F0.5	300 rpm – 2 000 rpm
Eppendorf ThermoMixer F1.5	300 rpm – 1 500 rpm
Eppendorf ThermoMixer F2.0	300 rpm – 1 500 rpm
Eppendorf ThermoMixer FP	300 rpm – 2 000 rpm

10.5 Interface

USB interface	For connection to VisioNize and for software updates with the Eppendorf ThermoMixer Autoupdate.
---------------	---

Declaration of Conformity

The product named below fulfills the requirements of directives and standards listed. In the case of unauthorized modifications to the product or an unintended use this declaration becomes invalid.

Product name:

Eppendorf ThermoMixer® F1.5, Eppendorf ThermoMixer® FP

Eppendorf ThermoMixer® F0.5, Eppendorf ThermoMixer® F2.0

including accessories

Product type:

Thermomixer for test tubes and plates

Relevant directives / standards:

2014/35/EU: EN 61010-1, EN 61010-2-010, EN 61010-2-051

UL 61010-1, CAN/CSA C22.2 No. 61010-1

2014/30/EU: EN 55011, EN 61326-1

2011/65/EU: EN 50581

Date: June 06, 2016



Management Board



Portfolio Management

Your local distributor: www.eppendorf.com/contact
Eppendorf AG · 22331 Hamburg · Germany
eppendorf@eppendorf.com

Eppendorf® and the Eppendorf logo are registered trademarks of Eppendorf AG, Germany.
U.S. Design Patents are listed on www.eppendorf.com/ip.
All rights reserved, incl. graphics and pictures. Copyright 2016 © by Eppendorf AG.

www.eppendorf.com

ISO 9001
Certified

ISO
13485
Certified

ISO
14001
Certified



Evaluate Your Manual

Give us your feedback.
www.eppendorf.com/manualfeedback

Your local distributor: www.eppendorf.com/contact
Eppendorf SE · Barkhausenweg 1 · 22339 Hamburg · Germany
eppendorf@eppendorf.com · www.eppendorf.com