



# Orion Lab Star PH111 pH/mV Bench Meter User Manual

68X002222 | Revision 01 | June 2022



# Table of Contents

Chapter 1 .....	6
Introduction .....	6
1.1 Intended Use.....	6
1.1.1 Intended Use .....	6
1.1.2 Non-Intended Use .....	6
1.1.3 Safety .....	6
1.1.4 Power Connection .....	6
1.2 Cleaning Instructions (Meter Only).....	6
Chapter 2 .....	7
Getting Started .....	7
2.1 Electrode Holder Installation .....	7
2.2 Universal Power Supply Assembly .....	8
2.3 Keypad Functions .....	9
2.3.1 Setup Menu Scrolling.....	9
2.3.2 Setup Menu Value Changes.....	9
2.3.3 Mode Shortcut Key.....	9
2.3.4 Date and Time View Shortcut Key.....	9
2.4 Display Overview .....	10
2.5 Meter Connections .....	11
2.6 Electrode Information .....	11
2.7 Meter Startup Sequence.....	11
Chapter 3 .....	12
Setup Menu.....	12
3.1 Setup Menu Overview .....	12
3.2 Setup Menu Items .....	13
3.2.1 View Logs.....	13
3.2.1a Viewing the Data Log.....	13
3.2.1b Viewing the Calibration Log.....	14
3.2.2 Log Export Type .....	15
3.2.3 Export All Logs .....	15
3.2.4 Temperature Calibration or Manual Temperature Input .....	16

3.2.4a Temperature Calibration.....	16
3.2.4b Manual Temperature Input .....	16
3.2.5 Measure Mode .....	17
3.2.6 pH Resolution .....	17
3.2.7 Calibration Buffer Set .....	18
3.2.8 Read Type .....	18
3.2.9 Timed Interval .....	19
3.2.10 Calibration Due Alarm .....	19
3.2.11 Temperature Units .....	20
3.2.12 Set Date Format .....	20
3.2.13 Set Date Value .....	21
3.2.14 Set Time Value.....	22
3.2.15 Audio Mode.....	22
3.2.16 Sleep Mode .....	23
3.2.17 Clear Data .....	23
3.2.18 Factory Reset .....	24
Chapter 4 .....	25
Calibration .....	25
4.1 pH Calibration .....	25
4.1.1 pH Calibration Overview.....	25
4.1.2 pH Calibration Procedure.....	25
4.1.3 pH Calibration Example.....	26
4.1.4 pH Value vs. Temperature.....	27
4.2 Millivolt (mV) Offset Adjustment .....	28
4.3 Temperature Calibration .....	28
Chapter 5 .....	29
Measurements.....	29
5.1 Read Types.....	29
5.1.1 Continuous .....	29
5.1.2 Auto-Read .....	29
5.1.3 Timed .....	29
5.2 pH and ORP Measurements.....	29
5.3 pH Electrode Icon .....	29
5.4 Data Viewing .....	30
5.5 Data Exporting .....	30
5.5.1 USB Computer Cable Interfacing .....	30

5.5.2 Remote Commands.....	31
5.6 Software Update Procedure .....	32
Chapter 6 .....	33
Troubleshooting.....	33
6.1 Meter Troubleshooting.....	33
6.2 Measurement Troubleshooting .....	33
6.3 Technical Support .....	33
Chapter 7 .....	34
Meter Info .....	34
7.1 Meter Specifications .....	34
7.2 Meter Dimensions .....	35
7.3 Warranty .....	35
7.3.1 Return of Items .....	35
Chapter 8 .....	36
Regulatory Compliance.....	36
8.1 European Union .....	36
8.2 Product Safety .....	36
8.3 Electromagnetic Compatibility.....	36
8.3.1 FCC Statement (USA) .....	36
8.4 Canadian ISED IC Notice.....	36
8.5 Environmental Compliance .....	36
8.5.1 REACH - Europe .....	36
8.5.2 RoHS - Europe.....	36
8.6 WEEE Compliance .....	37
Chapter 9 .....	38
Ordering Info.....	38
9.1 Meter Ordering Information .....	38
9.2 Electrode and Solution Ordering Info...	38

# Chapter 1

## Introduction

Thank you for purchasing the Thermo Scientific™ Orion™ Lab Star PH111 pH/mV bench meter. The Orion Lab Star meters are designed to provide the important functions needed for routine measurements with simplified, convenient, easy-to-use functionality.

The Orion Lab Star PH111 pH meters are capable of measuring pH or ORP simultaneously with mV and temperature. These meters offer a large, backlit display for clear viewing with small footprint to conserve laboratory bench space.

Ensure important data is preserved with a 500-point data log with date/time stamp that can also be exported to a printer or computer using the meter communication port.

All Orion Lab Star PH111 pH meters include a meter-attached electrode holder, computer cable and universal 100-240V 50/60 Hz power adapter with wall plugs for US/Japan, Euro, UK/Singapore, Australia/New Zealand and China. Additional meter accessories can be viewed at [www.thermofisher.com/electrochemistry](http://www.thermofisher.com/electrochemistry).

## 1.1 Intended Use

### 1.1.1 Intended Use

This device is a bench laboratory meter intended for use in a typical, indoor, controlled, laboratory environment. This device should only be used for analytical testing in accordance with these instructions.

### 1.1.2 Non-Intended Use

This device is not a Medical Device. It is not intended to be used to diagnose, treat, cure, or prevent disease.

### 1.1.3 Safety



**CAUTION:** This symbol, in the context of a CAUTION, indicates a potentially hazardous situation which if not avoided could result in minor to moderate injury or damage to the equipment.



**Note:** This symbol, in the context of a Note, indicates to follow the manufacturer specified instructions, notes and requirements set out in the manuals.



**CAUTION:** Before using or maintaining this product, please be sure to read the manual carefully. Failure to follow these instructions may cause the product to malfunction.



**CAUTION:** Use this product only in the way described in the product literature and in this manual. Before using it, verify that this product is suitable for its intended use. If the product is used in a manner not specified by the manufacturer, the protection provided by the product may be impaired.



**CAUTION:** Do not modify system components. Use OEM exact replacement equipment or parts. Before use, confirm that the product has not been altered in any way.



**Note:** Unauthorized repair of your meter will invalidate the warranty. For additional information, contact Technical Support at 1-800-225-1480, +1-978-232-6000 or [wlp.techsupport@thermofisher.com](mailto:wlp.techsupport@thermofisher.com).

## 1.1.4 Power Connection

See the [Universal Power Supply Assembly](#) section for complete instructions on assembling and installing the included meter power supply.



**Note:** Position the meter so the user can access power connection and unplug power adapter in the event of a fault, so hazard of electrocution can be removed.

## 1.2 Cleaning Instructions (Meter Only)

Wipe the exterior surfaces (except the display panel) using a lint-free cloth dampened with clean water.

Wipe the display panel with a clean microfiber cloth, taking care to wipe lightly to avoid scratching the meter display.

The meter keypad can also be cleaned using a clean microfiber cloth dampened with IPA (isopropyl alcohol) for disinfection purposes.

# Chapter 2

## Getting Started

### 2.1 Electrode Holder Installation

The meter-attached electrode holder (Catalog Number LSTAR-ARM) can be installed on either side of the meter.

1. Unpack the base plate and stand with electrode holder from the meter box.
2. Turn the meter over, with the meter display facing down, on a clean dry surface.
3. Identify the side of the meter that the holder will be installed on and remove the screw between the circles on that side of the meter.
4. Align the base plate of the holder with the circles on the meter.

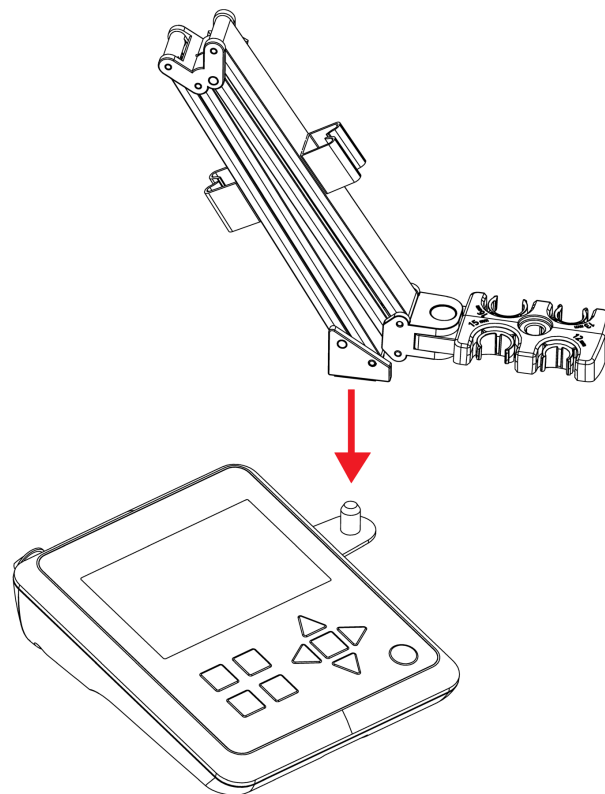

8. Place the electrodes into the electrode holder. The recommended electrode diameter for each slot is shown on the holder.

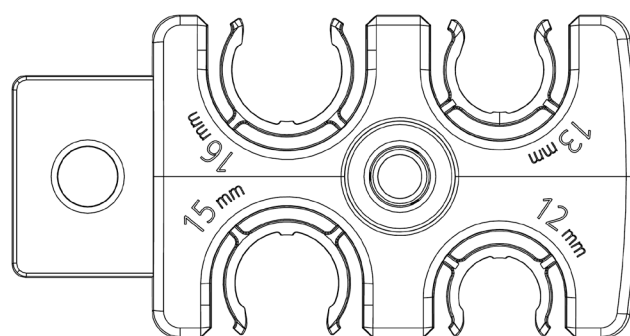
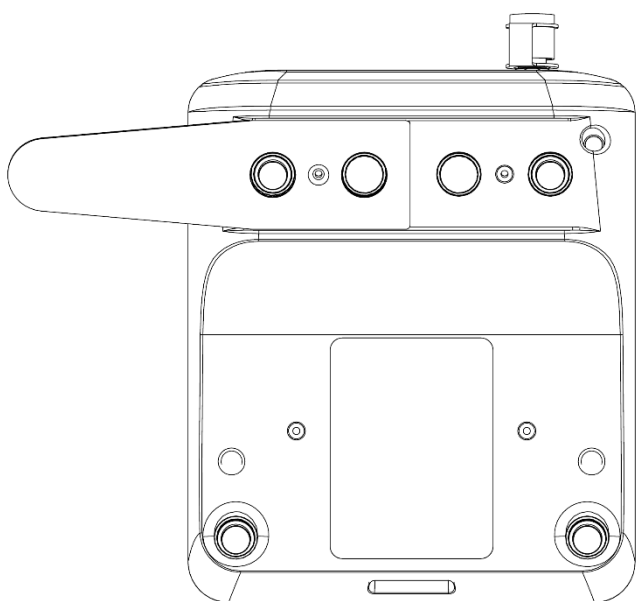

The recommended location for the ATC temperature probe is in the middle slot, which allows the ATC probe to be near the sensing electrode.

5. Replace the screw from step 3 to attach the base plate to the meter.
6. Turn the meter over, with meter display facing up.
7. Insert the stand with electrode holder into the metal post on the base plate.

## 2.2 Universal Power Supply Assembly

A universal power adapter (Catalog Number LSTAR-PWR) with US/Japan, Euro, UK/Singapore, Australia/New Zealand and China wall plug plates is included with the meter. This universal power adapter is specifically for use with this meter. Use of other power adapters can damage the meter and will void the warranty.

**Note:** The power adapter plug has two prongs that allow the power adapter to be locked onto the meter. These two prongs must be properly aligned when connecting it to ensure it is fully connected and locked onto the meter.

1. Unpack the power supply provided with the meter.
2. Select the appropriate wall plug plate for the power outlet that will be used.
3. Slide the appropriate wall plug plate into the groove on the back of the power adapter.

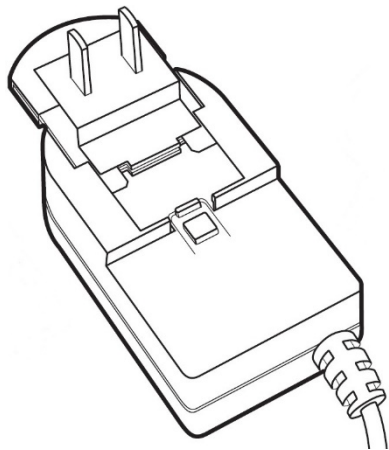

4. Connect the assembled power adapter to the meter input.

- a. Locate the two slots on the meter power input.

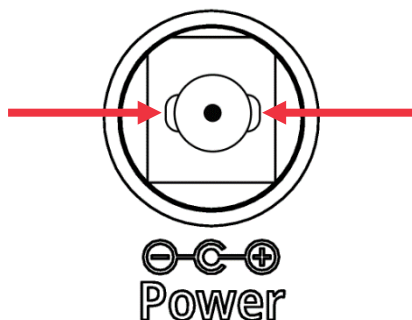

- b. Align the two tabs on the power adapter connector with the two slots on the meter power input.

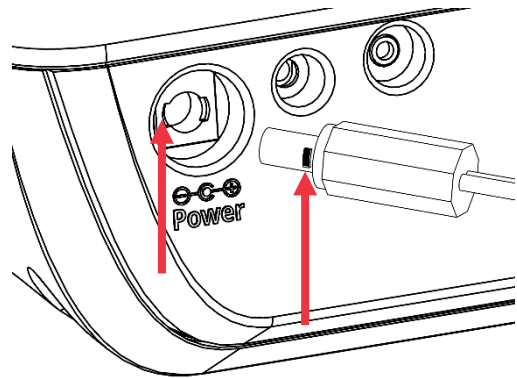

- c. Insert the power adapter connector into the meter power input and twist clockwise to lock the connection.

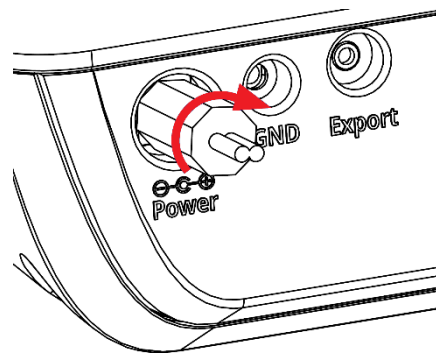

5. Connect the assembled power adapter to a power outlet.
6. You are now ready to turn on the meter.



**CAUTION:** Use of a surge protector or uninterruptible power supply (UPS) is recommended, as an unintended power surge of electricity to the meter may damage the meter and void the warranty.



## 2.3 Keypad Functions

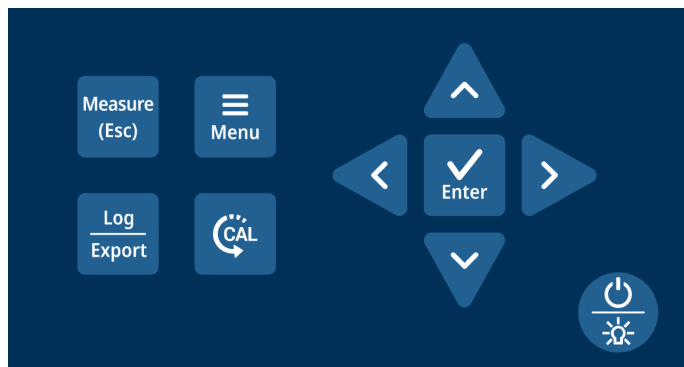

Key	Function
	In Auto-Read measure mode, press to start a new reading. Press to escape the Setup Menu and Calibration mode without saving changes.
	In Continuous measure mode, press to save the reading to the data log and export to an external device if one is connected.
	Press to enter the Setup Menu. Press to exit the Setup Menu.
	Press to enter the Calibration mode. Press while in the Calibration mode to save and end the calibration when performing a one to four point pH calibration.
	Press to scroll through menu items in the Setup Menu; the list is cyclical.
	In the Measure mode, press and hold (long press) for three seconds as a shortcut key to change the measure type from pH to RmV.
	Press to change a setting in the Setup Menu. Press to scroll through a list or change a numeric value.
	In the Calibration mode, press to manually change the calibration value. In the Measure mode, press and hold (long press) for three seconds as a shortcut key to view current date and time setting.
	Press to save a setting in the Setup Menu. Press to accept a calibration point in the Calibration mode.
	Press to power on the meter. When the meter is on, press to turn the backlight off or on. When the meter is on, press and hold for three seconds to power off the meter.

### 2.3.1 Setup Menu Scrolling

To scroll through the Setup Menu list:

- Press the “Menu” key to enter the Setup Menu.
- The first Setup Menu item will always be show.
- Press the ▷ key to scroll to the second item or press the ◁ key to scroll to the last item.
- The item list is cyclical and will scroll from the last item to the first item as the ▷ key is pressed.

### 2.3.2 Setup Menu Value Changes

For all numeric value changes, press the Δ or ∇ key to edit a value:

- Press the Δ key once to increase the value by one least significant digit/unit.
- Press the ∇ key once to decrease the value by one least significant digit/unit.
- Press and hold the Δ key to quickly increase the numeric value.
- Press and hold the ∇ key to quickly decrease the numeric value.

### 2.3.3 Mode Shortcut Key

In the main measure mode, press and hold (long press) the ◁ or ▷ key for approximately three seconds to change the main measure mode to pH or relative mV (RmV).

### 2.3.4 Date and Time View Shortcut Key



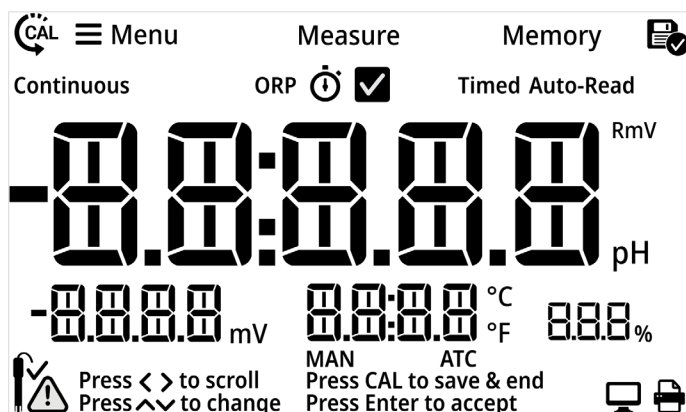

In the main measure mode, press and hold (long press) the Δ or ∇ key for approximately three seconds to view the current date and time settings.

## 2.4 Display Overview



Icon	Description
	<b>Main Measurement Field:</b> Displays pH or RmV readings in Measure mode.
	<b>2nd Measurement Field:</b> Displays raw mV readings in Measure mode.
	<b>3rd Measurement Field:</b> Displays temperature value as °C or °F in Measure mode.
	<b>4th Measurement Field:</b> Displays calibration slope value in Measure mode.
<b>Press &lt; &gt; to scroll</b>	<b>Press &lt; &gt; to scroll Icon:</b> On-screen text prompt shown when keys can be used to scroll through a list; for example, scroll through list of Setup Menu options.
<b>Press ^ v to change</b>	<b>Press ^ v to change Icon:</b> On-screen text prompt shown when keys can be used to change a value; for example, to change the temperature value in the Setup Menu.
<b>Press CAL to save &amp; end</b>	<b>Press CAL to save &amp; end Icon:</b> On-screen text prompt shown when in calibration mode and calibration can be saved and ended, when one to four points are complete.
<b>Press Enter to accept</b>	<b>Press Enter to accept Icon:</b> On-screen text prompt shown when changes must be saved by pressing the "Enter" key on the keypad.

Icon	Description
	<b>Calibration Icon:</b> Indicates meter is in the calibration mode; also shown with the Setup Menu Icon and Memory Icon when viewing the calibration log.
	<b>Setup Menu Icon:</b> Indicates meter is in the Setup Menu mode.
<b>Measure</b>	<b>Measure Icon:</b> Indicates meter is in the Measure mode.
<b>Memory</b>	<b>Memory Icon:</b> Indicates meter is in the Setup Menu and viewing the data log or calibration log.
	<b>Log Saved Icon:</b> Indicates meter is actively saving data to the data log or calibration log.
<b>Continuous</b>	<b>Continuous Icon:</b> Indicates the current meter read type is Continuous and measurement values are continuously updated on the display.
<b>ORP</b>	<b>ORP Icon:</b> Indicates the Orion ORP standard value was automatically recognized in the RmV calibration.
	<b>Stopwatch Icon:</b> Indicates stability criteria for current measurement is stabilizing/not ready and meter is actively reading.
	<b>Checkmark Icon:</b> Indicates stability criteria for current measurement is stable/ready and meter has determined the measurement is complete.
<b>Timed</b>	<b>Timed Icon:</b> Indicates the current meter read type is Timed, measurement values are continuously updated on the display and logged/exported according to the selected time intervals.
<b>Auto-Read</b>	<b>Auto-Read Icon:</b> Indicates the current meter read type is Auto-Read, measurement value is updated on the display until stable and then measurement is logged/exported and locked on display until the "Measure" key is pressed again.
<b>MAN</b>	<b>MAN Icon:</b> Indicates no temperature probe is connected to the meter, user must use the Setup Menu to enter the sample temperature.
<b>ATC</b>	<b>ATC Icon:</b> Indicates a temperature probe is connected to the meter and actively sending temperature readings.

Icon	Description
	<b>Electrode Good Icon:</b> Indicates the pH electrode condition is good, based on the last saved calibration data and resulting slope value.
	<b>Electrode Warning Icon:</b> Indicates the pH electrode condition is fair or bad, based on the last saved calibration data and resulting slope value.
	<b>Computer Export Icon:</b> Indicates meter is actively exporting measurement data or calibration data to a computer.
	<b>Printer Export Icon:</b> Indicates meter is actively exporting measurement data or calibration data to a printer.

## 2.5 Meter Connections

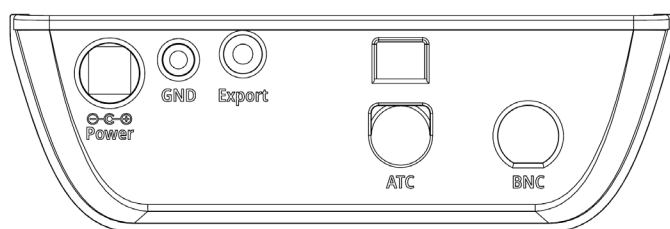

Input	Function
Power	Universal power supply
GND	Ground
Export	Connection to printer or computer
ATC	Connection to ATC temperature probe
BNC	Connection to pH or ORP (redox) electrode

## 2.6 Electrode Information

The Orion Lab Star PH111 pH/mV meter is compatible with pH electrodes and ORP (redox) electrodes with a BNC connector. The Orion Lab Star PH111 pH/mV meter can be purchased in a meter only configuration (purchase electrode separately) or kitted with different electrodes.

Refer to the electrode instructions for specific care and maintenance procedures. The following are general recommendations for electrode preparation.

1. Remove the protective cap/bottle from the electrode and save for storage.
2. Rinse any salt deposits off the electrode using distilled or deionized water.
3. If the electrode is refillable, uncover the fill hole and add filling solution to the electrode up to the fill hole. The fill hole should remain open when the electrode is in use.
4. Soak the electrode in storage solution when first preparing the electrode and when the electrode is not in use.
5. Connect the electrode to the meter.

## 2.7 Meter Startup Sequence

When the meter is powered on, it displays a set of startup screens, starting with all segments lit screen, followed by the meter info screen and then the meter self-test screen.

The meter info screen shows the meter model number and current software revision.

After the meter info screen, the meter performs a series of internal self-tests to verify that the meter is operating correctly and then the self-test results are shown.

Finally, the meter proceeds to the main measure mode.

# Chapter 3

## Setup Menu

### 3.1 Setup Menu Overview

Use the meter Setup Menu to customize meter settings.

1. In the Measure Mode, press the “Menu” key to access the meter Setup Menu.
2. The first Setup Menu item (View Logs, Data Log) will be shown. To scroll through the Setup Menu list, press the ◀ or ▶ key.
  - a. Press the ▶ key to scroll to the second item.
  - b. Press the ◀ key to scroll to the last item.
  - c. The list is cyclical, so continue to press the ▶ key to scroll from the last item to the first item.
3. To change a setting within a Setup Menu item, press the △ or ▽ key.
  - a. For numeric value changes:
    - i. Press the △ key once to increase the value by one least significant digit/unit.
    - ii. Press the ▽ key once to decrease the value by one least significant digit/unit.
    - iii. Press and hold the △ key to quickly increase the value.
    - iv. Press and hold the ▽ key to quickly decrease the value.
4. Once a setting is changed, press the “Enter” key to save the change.
5. When viewing data logs or calibration logs, press the “Menu” key to go back to the main Setup Menu list.
6. Press the “Measure” key at any time to exit the Setup Menu and return to the measure mode.

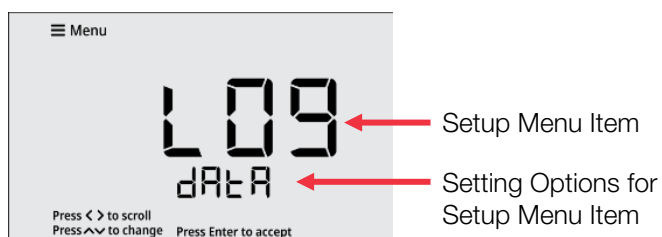

#	Setup Menu Item	Description
1	View Logs	View up to 500 data log points and active pH, RmV and temperature calibrations
2	Log Export Type	Set the export type as computer or printer or turn export off
3	Export All Logs	Send all saved data logs and calibration logs to the selected export device
4	Temperature Calibration or Manual Temperature Input	When an ATC probe is connected, use the Temp. Calibration menu to perform a temperature offset calibration When no ATC probe is connected, use the Manual Temp. Input menu to enter the sample temperature value
5	Measure Mode	Set the main measure mode to pH or relative mV (RmV)
6	pH Resolution	Set the displayed pH resolution as 0.1, 0.01 or 0.001 pH units
7	Calibration Buffer Set	Set the pH buffers to be used for automatic buffer recognition during pH calibrations
8	Read Type	Set the read type to define how measurements are performed and when measurements are saved and exported
9	Timed Interval	When Timed is set as the Read Type, set the time interval to be used to automatically save and export measurements
10	Calibration Due Alarm	Set the calibration due alarm interval; an alarm is triggered if a calibration is not performed within the specified time interval
11	Temp. Units	Set the temp. units as °C or °F
12	Set Date Format	Set the date format as month-day-year (MM.DD.YYYY) or day-month-year (DD.MM.YYYY)
13	Set Date Value	Set the day, month and year
14	Set Time Value	Set the time in AM/PM or 24 hour formats
15	Audio Mode	Set the audible beep on or off
16	Sleep Mode	Set the sleep mode on or off
17	Clear Data	Erase all data or calibration logs
18	Factory Reset	Erase all data logs, calibration logs and settings and return the meter to its factory default state

## 3.2 Setup Menu Items

### 3.2.1 View Logs

View up to 500 data log points and active pH, RmV and temperature calibrations. When the “Menu” key is pressed, the View Logs setup menu item is always shown first.

1. Press the  $\Delta$  or  $\nabla$  key to scroll through the data and calibration log options.



Press  $\nabla$  key

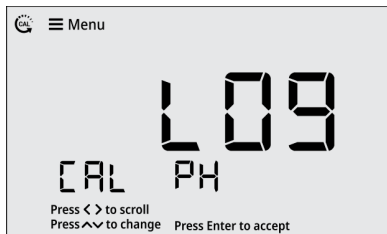

Press  $\nabla$  key

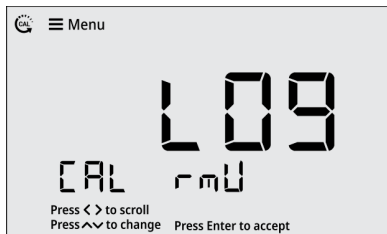

Press  $\nabla$  key

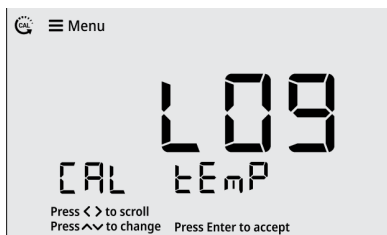

Press  $\nabla$  key

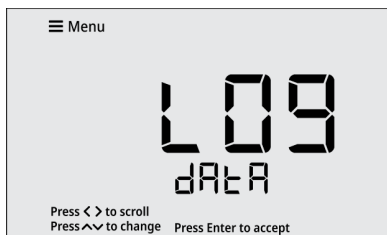

2. Press the “Enter” key to view the display log.

### 3.2.1a Viewing the Data Log

1. Press the “Enter” key to view the display log.



2. For the data log, press the  $\triangleleft$  or  $\triangleright$  key to scroll through the data log points. Scroll through data log points when viewing the date/time screens or the measurement data screens.



Press  $\triangleright$  key

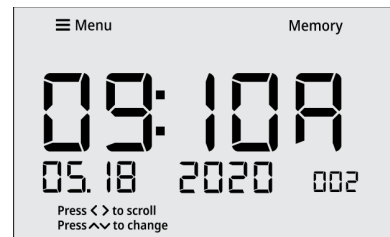

3. For the data log, press the  $\Delta$  or  $\nabla$  key to change the view from the date/time screen to the measurement data screen.

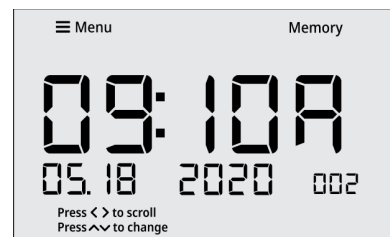

Press  $\Delta$  or  $\nabla$  key

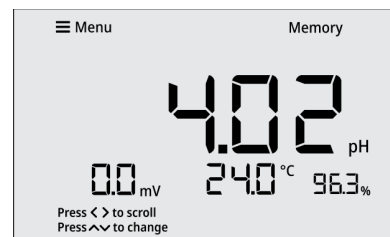

4. If desired, press the “Log/Export” key to export the individual data log point being viewed.
5. Press the “Menu” key to return to the main Setup Menu list.

### 3.2.1b Viewing the Calibration Log

1. Press the “Enter” key to view the display log.

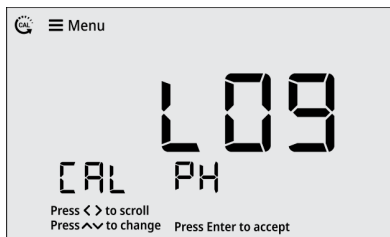

2. For the calibration log, press the  $\Delta$  or  $\nabla$  key to change the view from the date/time screen to the calibration data screen.



Press  $\Delta$  or  $\nabla$  key

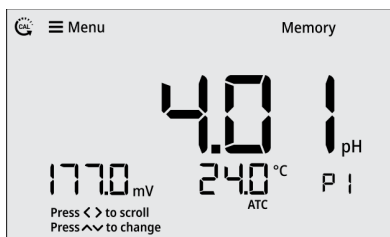

3. For the calibration log, press the  $\triangleleft$  or  $\triangleright$  key to scroll through the calibration log data.

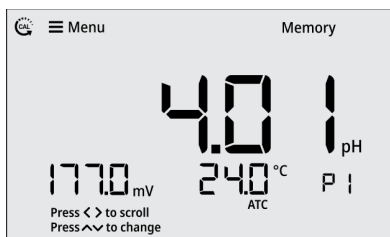

Press  $\triangleright$  key

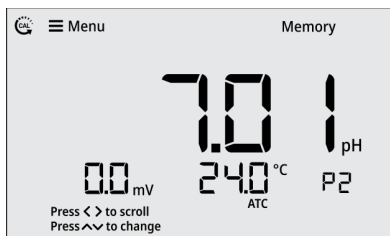

Press  $\triangleright$  key

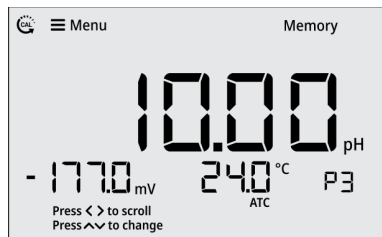

Press  $\triangleright$  key

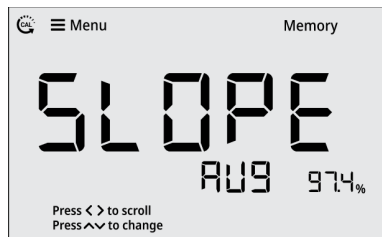

Press  $\triangleright$  key



Press  $\triangleright$  key



4. If desired, press the “Log/Export” key to export the individual calibration log being viewed.
5. Press the “Menu” key to return to the main Setup Menu list.

## 3.2.2 Log Export Type

Set the log export type as computer or printer or turn off the export function. If computer is selected, the logs are exported in CSV format. If printer is selected, the logs are exported in list format. If off is selected, no logs will be exported, and the Export All Logs menu will not be shown.

1. Press the ◀ or ▶ key to scroll through the Setup Menu list until the Log Export Type item is shown.

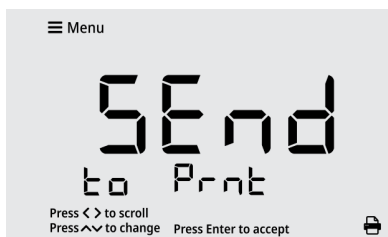

2. Press the ▲ or ▼ key to change the setting to computer, printer or off.

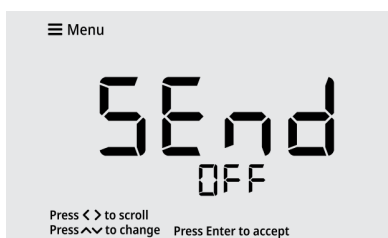
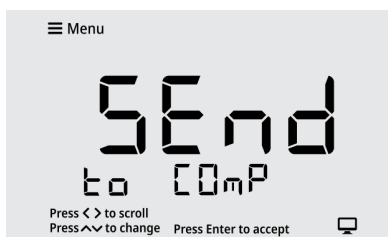

3. Press the “Enter” key to save the change.



## 3.2.3 Export All Logs

Send all saved data logs and calibration logs to the selected export device. Note that this menu will not be shown if the Log Export Type menu is set to off.

1. Press the ◀ or ▶ key to scroll through the Setup Menu list until the Export All Logs item is shown.



2. Press the “Enter” key to export all saved logs to the selected export device.
  - a. The display will show the data log numbers as they are exported in the 4<sup>th</sup> measurement field.
  - b. The computer or printer icon will blink as the logs are exported.

**Note:** If a large amount of data is exported, the meter may take a few minutes to complete exporting all saved data logs and calibration logs to the selected device.

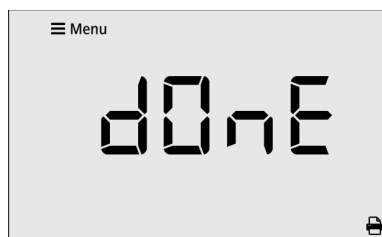

## 3.2.4 Temperature Calibration or Manual Temperature Input

### 3.2.4a Temperature Calibration

When an ATC probe is connected, use the Temperature Calibration menu to perform a one-point temperature offset calibration, up to  $\pm 5.0$  °C.

1. Press the  $\triangleleft$  or  $\triangleright$  key to scroll through the Setup Menu list until the Temp. Calibration item is shown.

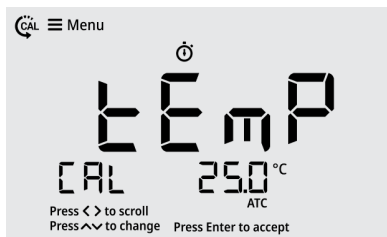

2. The temperature value will blink, indicating the reading from the ATC probe is being measured.
3. Once the reading is stable, the value will stop blinking and the checkmark icon will be shown.
4. Press the  $\triangle$  or  $\nabla$  key to adjust the temperature value in the 3<sup>rd</sup> field. The temperature offset value will be shown in the 2<sup>nd</sup> field.
  - a. Press the  $\triangle$  key to increase the value by 0.1°. Press and hold the  $\triangle$  key to quickly increase.
  - b. Press the  $\nabla$  key to decrease the value by 0.1°. Press and hold the  $\nabla$  key to quickly decrease.

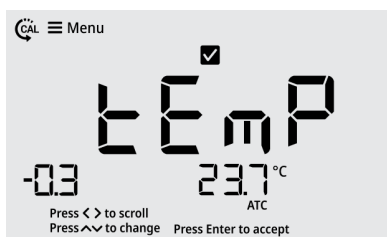

5. Press the “Enter” key to save the change.



### 3.2.4b Manual Temperature Input

When no ATC probe is connected, use the Manual Temperature Input menu to enter the sample temperature value, from -5.0 °C to 105.0 °C.

1. Press the  $\triangleleft$  or  $\triangleright$  key to scroll through the Setup Menu list until the Manual Temperature Input item is shown.

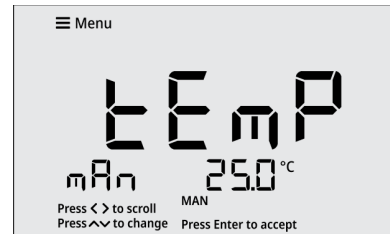

2. Press the  $\triangle$  or  $\nabla$  key to adjust the temperature value.
  - a. Press the  $\triangle$  key to increase the value by 0.1°. Press and hold the  $\triangle$  key to quickly increase.
  - b. Press the  $\nabla$  key to decrease the value by 0.1°. Press and hold the  $\nabla$  key to quickly decrease.

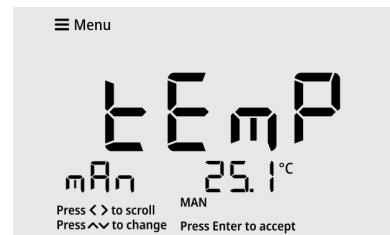

3. Press the “Enter” key to save the change.





### 3.2.5 Measure Mode

Set the main measure mode to pH or relative mV (RmV).

1. Press the < or > key to scroll through the Setup Menu list until the Measure Mode item is shown.

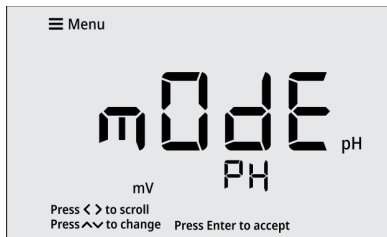

2. Press the Δ or ∇ key to set the measure mode.



3. Press the "Enter" key to save the change.



### 3.2.6 pH Resolution

Set displayed pH resolution as 0.1, 0.01 or 0.001 pH units.

1. Press the < or > key to scroll through the Setup Menu list until the pH Resolution item is shown.



2. Press the Δ or ∇ key to set the pH resolution.

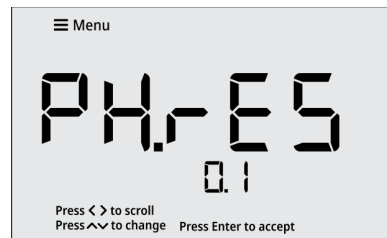

3. Press the "Enter" key to save the change.



### 3.2.7 Calibration Buffer Set

Set the pH buffer set as USA or DIN for automatic buffer recognition during pH calibrations.

**USA:** 1.68, 4.01, 7.00, 10.01, 12.46

**DIN:** 1.68, 4.01, 6.86, 9.18, 12.46

**Note:** During a pH calibration, pH buffer values can also be manually entered for each calibration point.

1. Press the < or > key to scroll through the Setup Menu list until the Calibration Buffer Set item is shown.

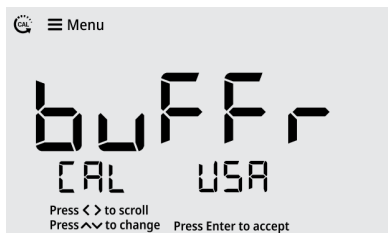

2. Press the Δ or ∇ key to set the pH buffer set.

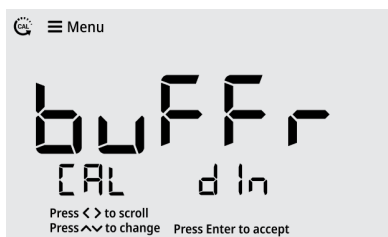

3. Press the “Enter” key to save the change.



### 3.2.8 Read Type

Set the Read Type as Continuous, Auto-Read or Timed to define how measurements are performed and when measurements are saved and exported.

#### Continuous:

In the Continuous measure mode, measurements are continuously updated on the display and the stopwatch (stabilizing) or checkmark (stable) icon indicates the measurement stability status. Press the “Log/Export” key to save a measurement to the data log and export.

#### Auto-Read:

In the Auto-Read measure mode, press the “Measure” key to start a measurement. When the measurement is stable, the checkmark (stable) icon is shown and the measurement is locked on the display until the “Measure” key is pressed again. The stable measurement is automatically saved to the data log and exported.

#### Timed:

In the Timed measure mode, the measurement values are continuously updated on the display. Measurements are automatically saved to the data log and exported at the selected time intervals, from 5 seconds to 60 minutes, the entire time the meter is in the measurement mode.

1. Press the < or > key to scroll through the Setup Menu list until the Read Type item is shown.

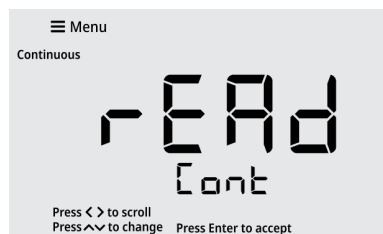

2. Press the Δ or ∇ key to set the read type.

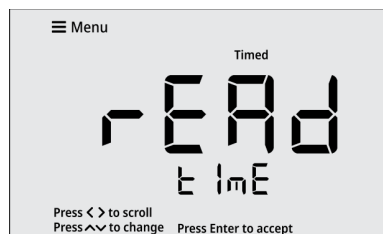

3. Press the “Enter” key to save the change.



### 3.2.9 Timed Interval

When Timed is set as the Read Type, set the time interval from 5 seconds to 60 minutes. This time interval is used to automatically save and export measurements.

1. Press the ◀ or ▶ key to scroll through the Setup Menu list until the Timed Interval item is shown.

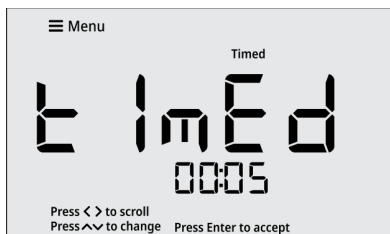

2. Press the ▲ or ▼ key to adjust the time value.
  - a. Press the ▲ key to increase the time value by one second. Press and hold the ▲ key to quickly increase.
  - b. Press the ▼ key to decrease the time value by one second. Press and hold the ▼ key to quickly decrease.

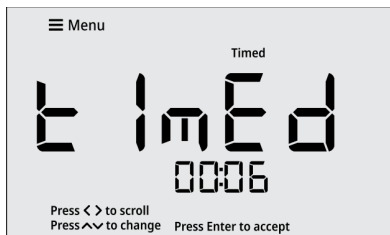

3. Press the "Enter" key to save the change.



### 3.2.10 Calibration Due Alarm

Set the calibration due alarm interval from 0 hours (off) to 168 hours. An alarm is triggered if a calibration is not performed within the specified time interval.

1. Press the ◀ or ▶ key to scroll through the Setup Menu list until the Calibration Due Alarm item is shown.



2. Press the ▲ or ▼ key to adjust the alarm value.
  - a. Press the ▲ key to increase the alarm value by one hour. Press and hold the ▲ key to quickly increase.
  - b. Press the ▼ key to decrease the alarm value by one hour. Press and hold the ▼ key to quickly decrease.

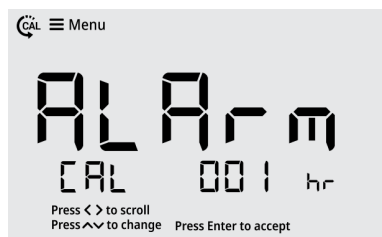

3. Press the "Enter" key to save the change.



### 3.2.11 Temperature Units

Set the temperature units as °C (Celsius) or °F (Fahrenheit).

1. Press the ◀ or ▶ key to scroll through the Setup Menu list until the Temperature Units item is shown.

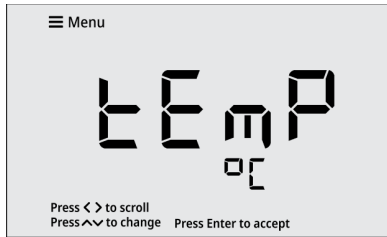

2. Press the ▲ or ▼ key to set the temperature units.

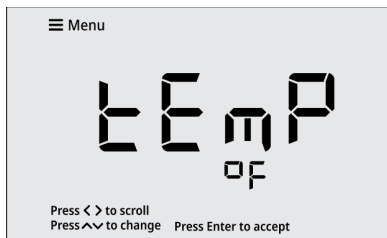

3. Press the "Enter" key to save the change.



### 3.2.12 Set Date Format

Set the date format as month-day-year (MM.DD.YYYY) or day-month-year (DD.MM.YYYY).

1. Press the ◀ or ▶ key to scroll through the Setup Menu list until the Set Date Format item is shown.



2. Press the ▲ or ▼ key to set the date format.



3. Press the "Enter" key to save the change.



## 3.2.13 Set Date Value

Set the month, day and year values.

The date format used for this Setup Menu item will match the setting in the Set Date Format item. For this example, the month-day-year (MM.DD.YYYY) format is shown.

1. Press the ◀ or ▶ key to scroll through the Setup Menu list until the Set Date Value item is shown.

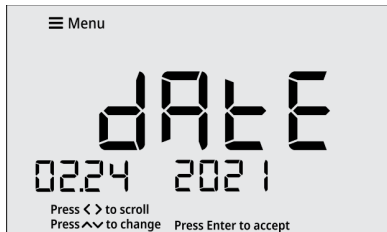

2. The month value will flash. Press the ▲ or ▼ key to adjust the month.
  - a. Press the ▲ key to increase by one month. Press and hold the ▲ key to quickly increase.
  - b. Press the ▼ key to decrease by one month. Press and hold the ▼ key to quickly decrease.
3. Press the “Enter” key to save the change.

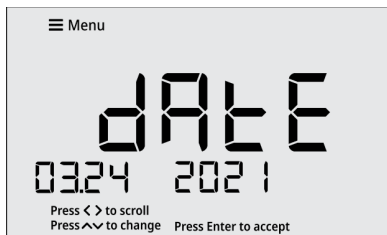

4. The day value will flash. Press the ▲ or ▼ key to adjust the day.
  - a. Press the ▲ key to increase by one day. Press and hold the ▲ key to quickly increase.
  - b. Press the ▼ key to decrease by one day. Press and hold the ▼ key to quickly decrease.
5. Press the “Enter” key to save the change.



6. The year value will flash. Press the ▲ or ▼ key to adjust the year.
  - a. Press the ▲ key to increase by one year. Press and hold the ▲ key to quickly increase.

- b. Press the ▼ key to decrease by one year. Press and hold the ▼ key to quickly decrease.

7. Press the “Enter” key to save the change.



### 3.2.14 Set Time Value

Set the time in AM/PM or 24 hour formats.

1. Press the ◀ or ▶ key to scroll through the Setup Menu list until the Set Time Value item is shown.

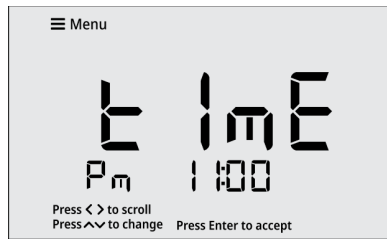

2. The AM/PM setting will flash. Press the ▲ or ▼ key to set the time as AM, PM or 24 hour format.
3. Press the “Enter” key to save the change.
4. The hour value will flash. Press the ▲ or ▼ key to adjust the hours.
  - a. Press the ▲ key to increase by one hour. Press and hold the ▲ key to quickly increase.
  - b. Press the ▼ key to decrease by one hour. Press and hold the ▼ key to quickly decrease.
5. Press the “Enter” key to save the change.
6. The minutes value will flash. Press the ▲ or ▼ key to adjust the minutes.
  - a. Press the ▲ key to increase by one minute. Press and hold the ▲ key to quickly increase.
  - b. Press the ▼ key to decrease by one minute. Press and hold the ▼ key to quickly decrease.
7. Press the “Enter” key to save the change.



### 3.2.15 Audio Mode

Set the audible beep on or off. The audible beep is used when an alarm is triggered.

1. Press the ◀ or ▶ key to scroll through the Setup Menu list until the Audio Mode item is shown.

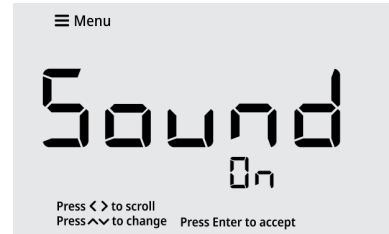

2. Press the ▲ or ▼ key to set the audio mode.



3. Press the “Enter” key to save the change.



### 3.2.16 Sleep Mode

Set the sleep mode on or off. When the meter sleep mode is on, the meter will enter sleep mode when no keys are pressed for 20 minutes. Once the meter is in sleep mode, press the “Power” key to resume using the meter. Make sure sleep mode is off when taking timed measurements.

1. Press the ◀ or ▶ key to scroll through the Setup Menu list until the Sleep Mode item is shown.

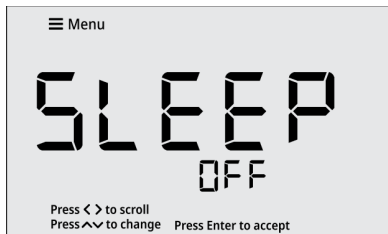

2. Press the ▲ or ▼ key to set the sleep mode.

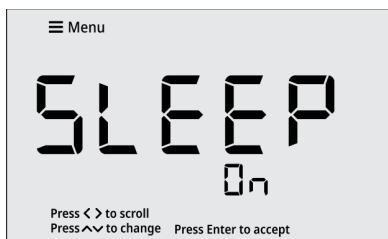

3. Press the “Enter” key to save the change.



### 3.2.17 Clear Data

Erase all data logs or erase all calibration logs

1. Press the ◀ or ▶ key to scroll through the Setup Menu list until the Clear Data item is shown.



2. Press the ▲ or ▼ key to select the data log (dAtA) or calibration log (CAL) to be cleared.



3. Press the “Enter” key to confirm the selection.

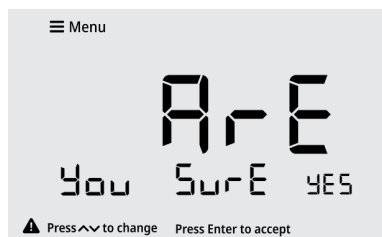

4. Press the “Enter” key again to ensure the selected log is not accidentally erased.
5. The meter will confirm when the selected log is fully erased.

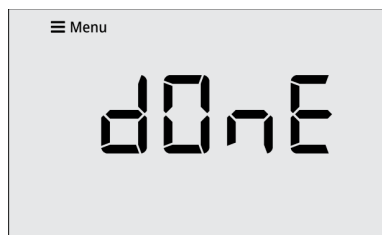

6. The meter will return to the measurement screen.

## 3.2.18 Factory Reset

Erase all data logs, calibration logs and settings and return the meter to its factory default state.

1. Press the ◀ or ▶ key to scroll through the Setup Menu list until the Factory Reset item is shown.

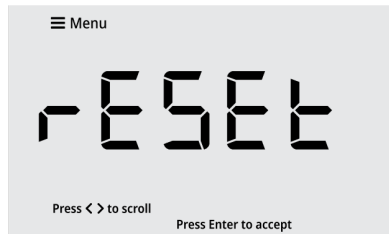

2. Press the "Enter" key to confirm the selection.

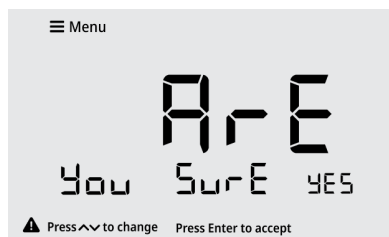

3. Press the "Enter" key again to ensure all meter data is not accidentally erased.
4. The meter will confirm when the factory reset is fully complete.

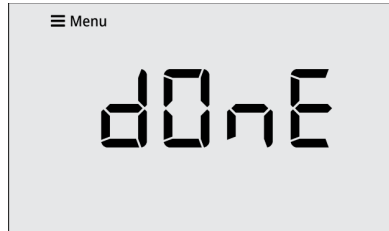

5. The meter will restart and then return to the measurement screen.



# Chapter 4

## Calibration

### 4.1 pH Calibration

#### 4.1.1 pH Calibration Overview

For best results, periodic calibration with known, accurate and fresh pH buffers is recommended. Calibrate with pH buffers that bracket the expected measuring range and include a neutral buffer. For example, if samples will be pH 6.2 to 9.5, calibrate with pH 4.01, 7.00, and 10.01 buffers. Perform one to five point pH buffers. The non-volatile meter memory retains the most recent, active calibration data when powered off.

During the pH calibration, the meter will automatically recognize each pH buffer value using the pH buffer set selected in the setup menu and the mV signal measured by the pH electrode. Once the reading is stable, the meter will automatically display the buffer value at its measured temperature from the selected buffer set.

The following pH buffers are automatically recognized:

- USA: 1.68, 4.01, 7.00, 10.01, 12.46
- DIN: 1.68, 4.01, 6.86, 9.18, 12.46

Refer to the [Calibration Buffer Set](#) section to change the pH buffer group.

If the mV value does not correspond to within  $\pm 60\text{mV}$  of a pH buffer in the selected buffer set, once the pH reading is stable, the meter will display the theoretical pH value of the buffer according to the last pH calibration that was performed or, if no calibration has been performed, the meter will display the theoretical pH value of the buffer according to the Nernst equation.

The pH buffer values can be manually entered for each calibration point. If the pH buffer value needs to be manually adjusted, use the  $\Delta$  or  $\nabla$  key to edit the value of the pH buffer at its measured temperature.

To eliminate temperature errors associated with pH, use an automatic temperature compensation (ATC) probe with pH electrode for best accuracy.

Press the “Cal” key to start and end the calibration. This allows pH calibrations to be performed using one to five

points without having to program the number of points before starting the calibration.

#### 4.1.2 pH Calibration Procedure

1. Ensure the active measure mode is pH.
2. Press the “Cal” key to start the calibration.
3. Rinse the pH electrode and ATC probe and place into the pH buffer.
4. Wait for the pH value to stabilize.
  - a. While the reading is stabilizing, the stopwatch icon is shown and the reading flashes.
  - b. When the reading is stable, the checkmark icon is shown, and the reading is solid.
5. Once the reading is stable, accept or edit the displayed pH buffer value:
  - a. To accept the pH buffer value, press the “Enter” key.or
  - b. To edit the pH buffer value, press the  $\Delta$  or  $\nabla$  key to change the value and then press the “Enter” key to save the value.
    - i. Press the  $\Delta$  key to increase by one digit. Press and hold the  $\Delta$  key to quickly increase.
    - ii. Press the  $\nabla$  key to decrease by one digit. Press and hold the  $\nabla$  key to quickly decrease.
6. Proceed to the next calibration point or save and end the calibration:
  - a. To proceed to the next calibration point, repeat steps 3-5.or
  - b. To save and end the calibration, press the “Cal” key.
    - i. When performing a one point pH calibration, press the  $\Delta$  or  $\nabla$  key to edit the slope value and then press the “Enter” key to accept.
7. The meter will display the calculated slope value and then proceed to the main measure mode.

**Note:** Press the “Measure” key at any time to abort the calibration and return to the main measure mode.

### 4.1.3 pH Calibration Example

The following is an example of a three point pH calibration using auto-recognized pH 4.01, 7.00 and 10.01 pH buffers. The pH buffers can be read in any order. For this example, pH buffers are read lowest to highest.

1. Press the “Cal” key to start the pH calibration. The active Calibration Buffer Set is shown.



2. Rinse the pH electrode and ATC probe and place into the pH 4.01 buffer.
3. Wait for the pH value to stabilize.

- a. When the reading is unstable, the stopwatch icon is shown and the reading flashes.

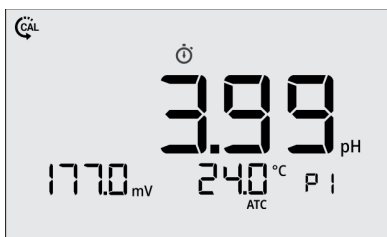

- b. When the reading is stable, the checkmark icon is shown and the reading is solid.

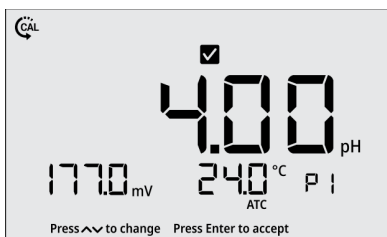

4. Once the reading is stable, press the “Enter” key. The meter will save the first calibration point and proceed to the next calibration point.



5. Rinse the pH electrode and ATC probe and place into the pH 7.00 buffer.
6. Wait for the pH value to stabilize.

- a. When the reading is unstable, the stopwatch icon is shown and the reading flashes.

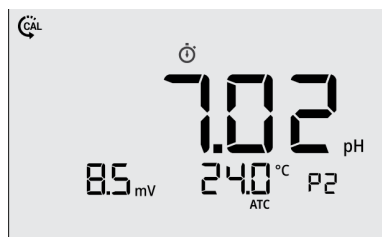

- b. When the reading is stable, the checkmark icon is shown and the reading is solid.

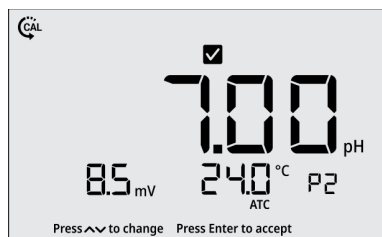

7. Once the reading is stable, press the “Enter” key. The meter will save the second calibration point and proceed to the next calibration point.



8. Rinse the pH electrode and ATC probe and place into the pH 10.01 buffer.

9. Wait for the pH value to stabilize.

- a. When the reading is unstable, the stopwatch icon is shown and the reading flashes.



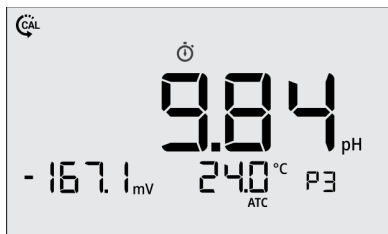

- b. When the reading is stable, the checkmark icon is shown and the reading is solid.

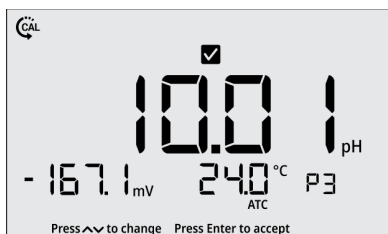

10. Once the reading is stable, press the “Enter” key. The meter will save the third calibration point.



11. Press the “Cal” key to end the calibration. The “Cal” key can be pressed when either the Saved or 4th Point screens is shown.



12. The average slope value is shown and then the Calibration Done screen is shown.

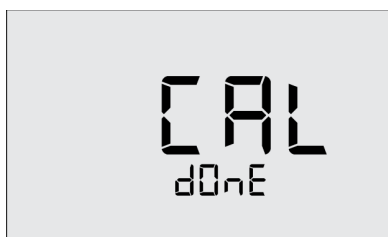

13. The meter will proceed to the main measure mode.

## 4.1.4 pH Value vs. Temperature

The following table lists theoretical values for the Orion pH buffers at various temperatures. Actual values displayed on the meter may vary slightly due to rounding deviations from the actual pH and temperature measurements.

### USA Buffer Set

Temp. (°C)	pH 1.68 Buffer	pH 4.01 Buffer	pH 7.00 Buffer	pH 10.01 Buffer	pH 12.46 Buffer
0	1.667	4.000	7.111	10.320	13.474
5	1.668	3.999	7.082	10.249	13.245
10	1.669	3.999	7.056	10.182	13.030
15	1.672	4.001	7.033	10.121	12.828
20	1.675	4.005	7.013	10.064	12.638
25	1.678	4.010	6.997	10.013	12.460
30	1.683	4.016	6.984	9.967	12.293
35	1.688	4.024	6.974	9.925	12.137
40	1.693	4.033	6.967	9.889	11.991
45	1.700	4.044	6.964	9.858	11.855
50	1.707	4.057	6.963	9.832	11.728
55	1.715	4.071	6.966	9.811	11.609
60	1.724	4.086	6.973	9.794	11.499
65	1.733	4.103	6.982	9.783	11.396
70	1.744	4.122	6.995	9.777	11.301
75	1.755	4.142	7.011	9.776	11.213
80	1.766	4.163	7.030	9.780	11.130

### DIN Buffer Set

Temp. (°C)	pH 1.68 Buffer	pH 4.01 Buffer	pH 6.86 Buffer	pH 9.18 Buffer	pH 12.46 Buffer
0	1.667	4.000	6.984	9.455	13.474
5	1.668	3.999	6.952	9.391	13.245
10	1.669	3.999	6.924	9.332	13.030
15	1.672	4.001	6.900	9.278	12.828
20	1.675	4.005	6.881	9.229	12.638
25	1.678	4.010	6.865	9.184	12.460
30	1.683	4.016	6.853	9.143	12.293
35	1.688	4.024	6.844	9.106	12.137
40	1.693	4.033	6.838	9.072	11.991
45	1.700	4.044	6.834	9.041	11.855
50	1.707	4.057	6.833	9.013	11.728
55	1.715	4.071	6.837	8.964	11.609
60	1.724	4.086	6.841	8.942	11.499
65	1.733	4.103	6.847	8.922	11.396
70	1.744	4.122	6.854	8.903	11.301
75	1.755	4.142	6.861	8.885	11.213
80	1.766	4.163	6.984	9.455	11.130

## 4.2 Millivolt (mV) Offset Adjustment

Oxidization Reduction Potential (ORP) or Redox is useful as a relative indicator of the oxidizing or reducing nature of a sample solution. The offset adjustment in the relative mV (RmV) mode allows readings to be comparable to reference. An offset of up to  $\pm 250$  mV from the measured raw mV value can be entered.

During the calibration, the meter will automatically recognize when the Orion ORP standard (catalog number 967901 or 967961) is used. Once the reading is stable, the meter will automatically display the value of the standard at its measured temperature.

Alternative ORP standards can also be used to perform the calibration. Once the reading is stable, manually enter the value of the standard at its measured temperature.

1. Ensure the active measure mode is RmV.
2. Press the “Cal” key to start the calibration.
3. Rinse the ORP electrode and ATC probe and place into the ORP standard.
4. Wait for the RmV value to stabilize.
  - a. While the reading is stabilizing, the stopwatch icon is shown and the reading flashes.
  - b. When the reading is stable, the checkmark icon is shown, and the reading is solid.
5. Once the reading is stable, accept or edit the displayed ORP standard value:
  - a. To accept the ORP standard value, press the “Enter” key.or
  - b. To edit the ORP standard value, press the  $\Delta$  or  $\nabla$  key to change the value and then press the “Enter” key to save the value.
    - iii. Press the  $\Delta$  key to increase by one digit. Press and hold the  $\Delta$  key to quickly increase.
    - iv. Press the  $\nabla$  key to decrease by one digit. Press and hold the  $\nabla$  key to quickly decrease.
6. The meter will display the calculated offset value and then proceed to the main measure mode.

**Note:** Press the “Measure” key at any time to abort the calibration and return to the main measure mode.

## 4.3 Temperature Calibration

The thermistor sensor used for automatic temperature compensation and measurement is both accurate and stable, so frequent calibration is not required.

When an ATC probe is connected to the meter, use the Temperature Calibration item within the Setup Menu to perform a one-point offset calibration, up to  $\pm 5.0$  °C.

Use the [Temperature Units](#) item in the meter Setup Menu to select the displayed temperature units as degrees Celsius or Fahrenheit.

1. Place the ATC probe into a solution with a stable temperature and NIST traceable thermometer.
2. Press the “Menu” key to enter the Setup Menu.
3. Press the  $\triangleleft$  or  $\triangleright$  key to scroll through the Setup Menu list until the Temp. Calibration item is shown.
4. The temperature value will blink, indicating the reading from the ATC probe is being measured.
5. Once the reading is stable, the value will stop blinking and the checkmark icon will be shown.
6. Press the  $\Delta$  or  $\nabla$  key to adjust the temperature value. The temperature offset value will be shown in the 2<sup>nd</sup> field.
  - c. Press the  $\Delta$  key to increase the value by 0.1°. Press and hold the  $\Delta$  key to quickly increase.
  - d. Press the  $\nabla$  key to decrease the value by 0.1°. Press and hold the  $\nabla$  key to quickly decrease.
7. Press the “Enter” key to save the change.

**Note:** Press the “Measure” key at any time to abort the calibration and return to the main measure mode.

# Chapter 5

## Measurements

### 5.1 Read Types

The [Read Type](#) selected in the meter Setup Menu will determine how measurements are performed and when measurements are saved to the data log and exported to an external device. Set the Read Type as Continuous, Auto-Read or Timed to define.

#### 5.1.1 Continuous

In the Continuous measure mode, measurements are continuously updated on the display and the stopwatch (stabilizing) or checkmark (stable) icon indicates the measurement stability status.

Press the “Log/Export” key to save a measurement to the data log and export.

#### 5.1.2 Auto-Read

In the Auto-Read measure mode, press the “Measure” key to start a measurement.

When the measurement is stable, the checkmark (stable) icon is shown and the measurement is locked on the display until the “Measure” key is pressed again.

The stable measurement is automatically saved to the data log and exported.

#### 5.1.3 Timed

In the Timed measure mode, the measurement values are continuously updated on the display.

Measurements are automatically saved to the data log and exported at the selected time intervals, from 5 seconds to 60 minutes, the entire time the meter is in the measurement mode.

### 5.2 pH and ORP Measurements

1. Rinse the electrode with distilled water or appropriate solution and blot gently with a lint-free tissue to remove excess water.
2. Place the electrode into the sample, submerging the measurement sensor and reference junction.
3. Allow time for the reading to stabilize.
  - a. The meter displays the stopwatch icon while the reading is stabilizing.
  - b. The meter displays the checkmark icon when the reading is stable.
4. Note the displayed measurements as required.
5. Remove the electrode from the sample.
6. Repeat steps 1-5 for all samples.
7. When all samples have been measured, store the electrode per instructions in the electrode manual.

### 5.3 pH Electrode Icon

The pH Electrode Icon indicates the condition of the pH electrode based on the last saved calibration data and resulting slope value.

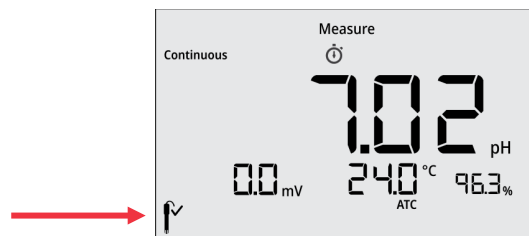

Electrode Good: pH calibration slope is 92.0% to 102.0%

Electrode Warning: pH calibration slope is 82.0% to 91.9% or 102.1% to 114.0%, recommended actions include:

- Check that all pH buffers are fresh, uncontaminated, and not expired
- Clean and condition the pH electrode

Electrode Error: pH calibration slope is less than 82.0% or higher than 114.0%, recommended actions include:

- Replace all pH buffers
- Replace pH electrode

Refer to the [Troubleshooting](#) section for more recommended actions.

## 5.4 Data Viewing

Store up to 500 data points in the meter memory. Use the [View Logs](#) item in the meter Setup Menu to view the data log points, active pH calibration log, active RmV calibration log and active temperature calibration log.

The data log shows the most recent data log point first. The meter will save up to 500 data log points and then automatically overwrite the oldest data log point with the newest data log point when the limit is reached. Each data log point is saved with its associated date and time stamp. To view the time stamp with seconds included, the data log must be exported to a computer or printer.

The pH calibration log shows each calibration point and the calculated slope value. Three, four and five point pH calibrations will display the average slope value and then the appropriate number of segmented slope values. The RmV calibration log shows the RmV value with raw mV value and temperature. The temperature calibration log shows the temperature and offset value. Each calibration log is saved with its associated date and time stamp. To view the time stamp with seconds included, the calibration log must be exported to a computer or printer.

**Note:** *If desired, when in the View Logs item in the meter Setup Menu, press the “Log/Export” key to export the individual data log point or calibration log being viewed.*

## 5.5 Data Exporting

Export data from the meter to a computer or printer. Use the [Log Export Type](#) item in the meter Setup Menu to set the export type as computer or printer.

If computer is selected, logs are exported in CSV format.

If printer is selected, logs are exported in list format.

### Meter Serial Communication Protocol

Computer Setting	Printer Setting
Baud Rate : 9600 bps	Baud Rate : 9600 bps
Data bits: 8	Data bits: 8
Parity: None	Parity: None
Stop bits: 1	Stop bits: 1
Flow Control: None	Flow Control: None

### 5.5.1 USB Computer Cable Interfacing

Orion Lab Star meters include a computer cable that allows the meter to be interfaced with a computer using a standard USB-A computer port.

1. Power on the meter.
2. First, connect the computer cable to the EXPORT port on the back of the meter.
3. Second, connect the computer cable to a standard USB-A port on the computer.
4. After the computer cable is connected to the computer, the computer should automatically identify the cable and install the required driver.
  - a. If the driver is not automatically installed, go to [www.thermofisher.com/orionsoftware](http://www.thermofisher.com/orionsoftware) and download the USB computer cable driver for Orion Lab Star series meters.
5. Once the driver is installed, data can be transferred from the meter to a computer using computer programs such as LIMs, Putty, LabView, HyperTerminal or similar programs.
  - a. To record the COM port location of the computer cable, use the computer’s Device Manager tool.

## 5.5.2 Remote Commands

Remote commands allow the meter to be interfaced with computer software like LIMs and HyperTerminal.

The remote engine receives input from the serial port and processes it. Commands sent to the remote interface will be in the form of "OPCODE <OPERAND> CR".

- Only one command can be executed at a time. A new command cannot be issued until the previous command is done and prompt is given, shown as the greater than symbol (">") followed by a space.
- Empty commands (i.e. just a <CR>) will be ignored and a new prompt will be issued.
- <CR> (Carriage Return, ASCII 13) is used to terminate a command. Whenever this character is received, the internal buffer will be processed.
- Remote commands are not case sensitive.

### Remote Commands List

Remote Command	Action	Example Command
GETMEAS <CR>	Prints the current measurement immediately	
GETMEAS <u>Data Count</u> <CR>	Prints the current measurement for a set number of times  <u>Data Count</u> = <u>1</u> , <u>2</u> , <u>3</u> , etc.	GETMEAS 2
GETCAL <CR>	Prints all current calibration data  If no calibration is saved, returns ">" to receive next command	
GETCAL <u>MODE</u> <CR>	Prints the calibration data for specific mode  <u>MODE</u> = <u>PH</u> or <u>RMV</u>	GETCAL PH
GETLOG <CR>	Prints all logged measurement data  Output format is based on the Log Export Type setting  If no data is logged, returns ">" to receive next command	

Remote Command	Action	Example Command
SYSTEM <CR>	Prints the system information including meter model, serial number, software version, date and time	
SETCSV <CR>	Sets the output format to Comma Separated Values (CSV)	
SETKEYLOCK <u>NUMBER</u> <CR>	Locks or unlocks the meter keypad  <u>NUMBER</u> = <u>1</u> (lock) or <u>0</u> (unlock)	SETKEYLOCK 1
SETRTC <u>YYYY-MM-DD-HH-MM-SS-</u> <u>TIMEMODE</u> <CR>	Sets the date and time for the meter  <u>TIME MODE</u> = <u>1</u> (PM), <u>2</u> (AM) or <u>3</u> (24 Hour)	SETRTC 2021-08-19- 01-32-00-1
SETMODE <u>MODE</u> <CR>	Sets the meter measurement mode.  <u>MODE</u> = <u>PH</u> or <u>RMV</u>	SETMODE PH
GETMODE <CR>	Prints the active measurement mode	

# 5.6 Software Update Procedure

A computer with Microsoft Windows 10, 64bit (x64 based processor) operating system is required to perform the software update procedure.

Computer screen savers and power management settings must be disabled so the computer does not enter sleep or standby mode while performing the software update.

Laptop computers may enter sleep or standby mode when the lid is closed, so the lid must remain open throughout the software update procedure. Laptop computers should also be connected to a power supply when performing the software update procedure.

**Note:** Back up all meter data before performing the software update procedure.

**Note:** Uninstall any previous versions of the Orion Lab Star meter software program using the computer's Programs and Features tool.

1. Make sure the meter is interfaced with the computer using the USB computer cable and the driver has been installed according to the instructions in the [USB Computer Cable Interfacing](#) section.
2. Power on the meter.
3. Download the latest Orion Lab Star meter software at [www.thermofisher.com/orionsoftware](http://www.thermofisher.com/orionsoftware).
4. Unzip/extract the Orion Lab Star meter software files to the computer's desktop.
5. Open the folder containing the unzipped/extracted software files and double click the setup.exe file to install the setup program onto the computer.
6. Follow all prompts to install the setup program onto the computer. If any security warning messages appear, select the run software option.
7. After successful installation of the setup program, a new icon will appear on the computer's desktop and start menu. Double click the icon from desktop or start menu to launch the program.
8. Follow all prompts, including reviewing and accepting the licensing agreement, to start the software update. If any security warning messages appear, select the run software option.
9. Set the interface parameters for running the software update program.

- a. Select "Serial" as the connection method.
  - b. Enter the COM port location of the USB computer cable (viewable in Device Manager under Ports).
  - c. Enter the meter baud rate as 9600.
10. Click the Upgrade Firmware button. Wait while the update is installed on the meter.
  11. The update will take approximately six minutes. Once the update is complete, the dialog box will show "Done!".
  12. Close the software update and detach the USB computer cable from the meter and computer.



# Chapter 6

## Troubleshooting

### 6.1 Meter Troubleshooting

Meter display not powering on:

- Verify that power cord is fully plugged into meter and wall outlet
- The power adapter plug has two prongs used to lock it onto the meter; ensure the prongs are properly aligned when connecting it with the meter
- Check that the wall outlet is functional
- Press the “Power” key on the meter

Meter not responding to any key presses:

- Check that the key being pressed is active in the current meter mode
- Unplug and reconnect the meter power supply
- Contact Technical Support

Meter error shown:

- pH Out of Range, RmV Out of Range, Temperature Out of Range:
  - Ensure electrode is connected to meter
  - Check that electrode does not have any damage or cracks
  - Ensure the electrode is properly immersed in the sample solution, with the electrode sensing bulb and reference junction submerged below the top of the sample solution
  - Verify cables do not have any damage
  - Perform a factor reset on the meter
- pH Electrode Icon:
  - Troubleshoot pH buffers and pH electrode
  - Replace pH buffers
  - Clean and condition pH electrode
  - Replace pH electrode as needed

### 6.2 Measurement Troubleshooting

Reading is unstable, slow to stabilize

- Clean electrode to remove build-up or contaminants, 0.1M HCl is recommended and adding pepsin is helpful if protein build-up occurs
- If electrode was stored dry, soak electrode in storage solution for at least 30 minutes
- If electrode is refillable, add electrode fill solution and ensure the fill hole is uncovered during use
- Check electrode for damage, cracks or breaks
- Check cables for damage or breaks
- Remove any interfering devices from area
- Replace old electrode with new electrode
- If sample temperature is changing, allow temperature to stabilize

Reading freezes on display

- Check meter [Read Type](#) setting
  - If meter Read Type is set to Auto-Read, press the “Measure” key to start a new measurement
- Check electrode for damage, cracks or breaks
- Check cables for damage or breaks
- Replace old electrode with new electrode

### 6.3 Technical Support

Contact our Orion Technical Support team at 1-800-225-1480, +1-978-232-6000 or [wlp.techsupport@thermofisher.com](mailto:wlp.techsupport@thermofisher.com)

# Chapter 7

## Meter Info

### 7.1 Meter Specifications

pH	
Range	-2.000 to 18.000 pH
Resolution	0.1, 0.01, 0.001 pH
Relative accuracy	±0.005 pH ± 1 LSD
Calibration points	1 to 5 points
Calibration method	Automatic buffer recognition with manual buffer entry option
Calibration pH buffer sets	USA: 1.68, 4.01, 7.00, 10.01, 12.46 DIN: 1.68, 4.01, 6.86, 9.18, 12.46
Slope display	Yes
mV / RmV / ORP	
Range	±2000 mV
Resolution	0.1 mV
Relative accuracy	±0.2 mV or ±0.05 % of the reading, whichever is greater
Calibration points	1 point
Offset adjustment	Up to ±250 mV
Temperature	
Range	-5.0 to 105.0 °C, 23.0 to 221.0 °F
Resolution	0.1 °C, 0.1 °F
Relative accuracy	±0.3 °C, ±0.5 °F
Calibration points	1 point
Offset adjustment	Up to ±5 °C
Features	
Display	5" backlit LCD
Time and date	Yes
Time format	12 hour AM/PM or 24 hour
Date format	Selectable, DD-MM-YYYY or MM-DD-YYYY
Read types	Continuous, Auto-Read, Timed
Timed interval	5 seconds to 60 minutes
Data log	500 sets with time and date

Calibration log	Active pH, ORP, temperature with time and date
Calibration alarm	Yes, 1 to 168 hours or off
Sleep mode	Yes, optional
Self-test	Automatic with startup
Memory	Non-volatile
Input	BNC, ATC
Data output	Computer or printer
Data output format	CSV or print
Warranty	3 years
Certifications	CE, TUV 3-1, FCC Class A
Enclosure	IP-54
Power	100-240 VAC, 50-60Hz, 9 DC adapter, 1.3A
Dimensions (L x W x H)	198.3 mm x 155.2 mm x 61.7 mm, 7.81" x 6.11" x 2.43"
Weight	700 grams, 1.54 lbs.
Environmental Conditions	
Environmental conditions	Indoors
Altitude	Up to 2,000 Meters
Operating temperature	5°C to 45°C
Operating relative humidity	5 to 85%, non-condensing
Storage temperature	-20°C to 60°C
Storage relative humidity	5 to 85%, non-condensing
Mains fluctuation	±10% of range (100-240VAC)
Installation category	II
Pollution degree	2
Protection class	III

## 7.2 Meter Dimensions

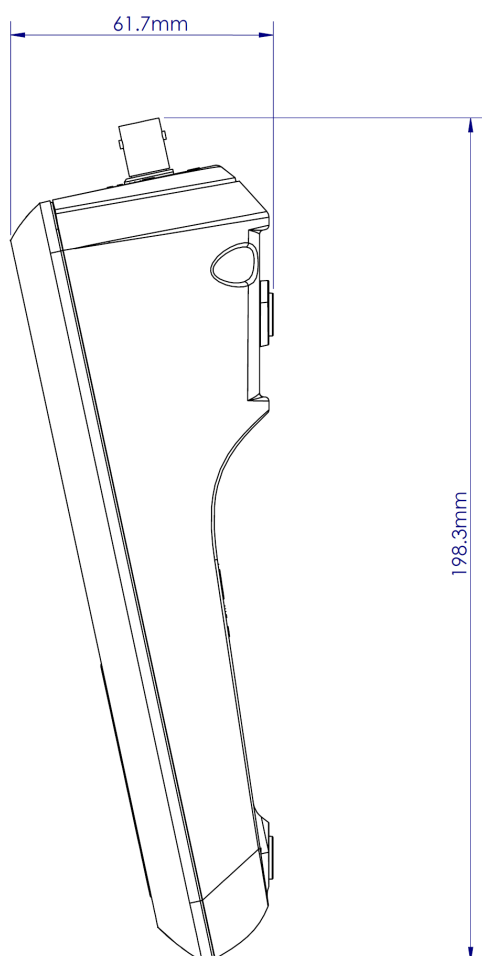
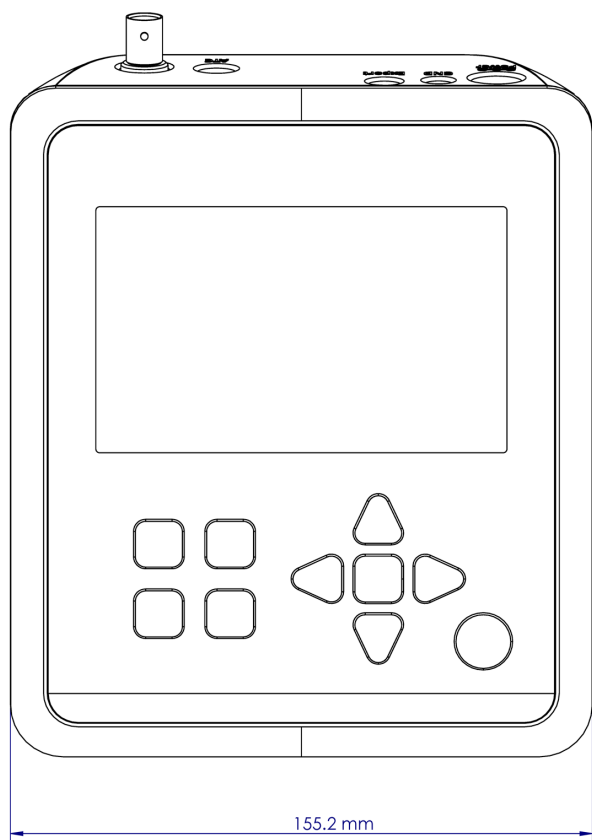

## 7.3 Warranty

This meter is supplied with a warranty against significant deviations in material and workmanship for a period of three (3) years from date of purchase. Electrode warranties are separate from the meter and differ based on the selected electrode.

If meter repair or adjustment is necessary within the designated warranty period and has not been the result of abuse or misuse, please contact the Technical Support Team for return authorization and a correction will be made without charge. The manufacturer will determine if the meter problem is due to deviations or customer misuse.

Out of warranty products will be repaired on a charged basis.

The warranty on your meter shall not apply to defects resulting from:

- Improper or inadequate maintenance by customer
- Unauthorized modification or misuse
- Operation outside of the environment specifications of the products

### 7.3.1 Return of Items

Authorization must be obtained from our Technical Support Team or authorized distributor before returning items for any reason. Please include data regarding the reason the items are to be returned. For your protection, items must be carefully packed to prevent damage in shipment and insured against possible damage or loss. The manufacturer will not be responsible for damage resulting from careless or insufficient packing. A restocking charge will be made on all unauthorized returns.

**Note:** The manufacturer reserves the right to make improvements in design, construction, and appearance of products without notice.

# Chapter 8

## Regulatory Compliance

### 8.1 European Union



The European voltage models of this product meet all the applicable requirements of the European Directives and therefore display the CE Marking. These Directives include those captured in the EU Declaration of Conformity. The most current EU Declaration of Conformity may be obtained from the manufacturer.

### 8.2 Product Safety

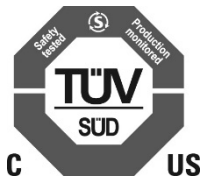

This product family has been tested to applicable product standards by TUV SUD a Nationally Recognized Test Laboratory (NRTL).

### 8.3 Electromagnetic Compatibility

#### 8.3.1 FCC Statement (USA)



Any changes or modifications not expressly approved by the party responsible for compliance could void the user's authority to operate the equipment.

**Note:** This equipment has been tested and found to comply with the limits for a Class A digital device, pursuant to part 15 of the FCC Rules. These limits are designed to provide reasonable protection against harmful interference when the equipment is operated in a commercial environment. This equipment generates, uses, and can radiate radio frequency energy and, if not installed and used in accordance with the instruction manual, may cause harmful interference to radio communications. Operation of this equipment in a residential area is likely to cause harmful interference in which case the user will be required to correct the interference at his own expense.

### 8.4 Canadian ISED IC Notice

This ISM digital apparatus complies with Canadian ICES-001.

Cet appareil ISM est conforme à la norme NMB-001 du Canada.

### 8.5 Environmental Compliance

#### 8.5.1 REACH - Europe

We are committed to meeting all compliance obligations to evaluate, communicate, and register any Substances of Very High Concern (SVHC), substances of authorization and finding alternates where appropriate.

#### 8.5.2 RoHS - Europe

We are determined to reduce the impact we have on the environment, and so can declare that this product fully complies with the European Parliament's RoHS2 and RoHS2 amendment (Restriction of Hazardous Substances) Directive 2011/65/EU and 2015/863/EU, with respect to all the following substances:

- Lead (0,1 %)
- Mercury (0,1 %)
- Cadmium (0,01 %)
- Hexavalent chromium (0,1 %)
- Polybrominated biphenyls (PBB) (0,1 %)
- Polybrominated diphenyl ethers (PBDE) (0,1 %)

- Bis(2-ethylhexyl) phthalate (DEHP) (0,1%)
- Butyl benzyl phthalate (BBP) (0,1%)
- Dibutyl phthalate (DBP) (0,1%)
- Diisobutyl phthalate (DIBP) (0,1%)

Our compliance relies on declarations from our suppliers, testing and evaluations per the assessment requirements defined in standard EN 63000:2018. This confirms that any potential trace contamination levels of the substances listed above are below the maximum level set by the latest regulations or are exempt due to their application.

## 8.6 WEEE Compliance



WEEE Compliance. This product is required to comply with the European Union's Waste Electrical & Electronic Equipment (WEEE) Directive 2012/19/EU. It is marked with the following symbol. Thermo Fisher Scientific has contracted with one or more recycling/disposal companies in each EU Member State, and this product should be disposed of or recycled through them. Further information on our compliance with these Directives, the recyclers in your country, and information on Thermo Scientific products which may assist the detection of substances subject to the RoHS Directive are available at [www.thermofisher.com/](http://www.thermofisher.com/)



WEEE Konformität. Dieses Produkt muss die EU Waste Electrical & Electronic Equipment (WEEE) Richtlinie 2012/19/EU erfüllen. Das Produkt ist durch folgendes Symbol gekennzeichnet. Thermo Fisher Scientific hat Vereinbarungen getroffen mit Verwertungs-/Entsorgungsanlagen in allen EU-Mitgliedstaaten und dieses Produkt muss durch diese Firmen wiederverwertet oder entsorgt werden. Mehr Informationen über die Einhaltung dieser Anweisungen durch Thermo Scientific, die Verwerter und Hinweise die Ihnen nützlich sein können, die Thermo Fisher Scientific Produkte zu identifizieren, die unter diese RoHS. Anweisung fallen, finden Sie unter

[www.thermofisher.com/](http://www.thermofisher.com/)



Conformità WEEE. Questo prodotto deve rispondere alla direttiva dell'Unione Europea 2012/19/EU in merito ai Rifiuti degli Apparecchi Elettrici ed Elettronici (WEEE). marcato col seguente simbolo. Thermo Fisher Scientific ha stipulato contratti con una o diverse società di riciclaggio/smaltimento in ognuno degli Stati Membri Europei. Questo prodotto verrà smaltito o riciclato tramite queste medesime. Ulteriori informazioni sulla conformità di Thermo Fisher Scientific con queste Direttive, l'elenco delle ditte di riciclaggio nel Vostro paese e informazioni sui prodotti Thermo Scientific che possono essere utili alla rilevazione di sostanze soggette alla Direttiva RoHS sono disponibili sul sito <http://www.thermofisher.com/>



Conformité WEEE. Ce produit doit être conforme à la directive euro-péenne (2012/19/EU) des Déchets d'Equipements Electriques et Electroniques (DEEE). Il est marqué par le symbole suivant. Thermo Fisher Scientific s'est associé avec une ou plusieurs compagnies de recyclage dans chaque état membre de l'union européenne et ce produit devrait être collecté ou recyclé par celles-ci. Davantage d'informations sur la conformité de Thermo Fisher Scientific à ces directives, les recycleurs dans votre pays et les informations sur les produits Thermo Fisher Scientific qui peuvent aider la détection des substances sujettes à la directive RoHS sont disponibles sur <http://www.thermofisher.com/>

# Chapter 9

## Ordering Info

### 9.1 Meter Ordering Information

Description	Catalog Number
Orion Lab Star PH111 pH/mV meter with stand, PC cable and universal power adapter	LSTAR1110
Orion Lab Star PH111 pH/mV meter standard kit, includes meter with stand, PC cable, universal power adapter, 9157BNMD refillable epoxy-body pH/ATC electrode, 916099 pH buffer and solution kit	LSTAR1115
Orion Lab Star PH111 pH/mV bench meter easy-to-clean bio kit, includes meter with stand, PC cable, universal power adapter, GD9156BNWP double junction refillable epoxy-body pH electrode, 927007MD stainless steel ATC temperature probe, 916099 pH buffer and solution kit	LSTAR1116
Orion Lab Star PH111 pH/mV bench meter low-maintenance bio kit, includes meter with stand, PC cable, universal power adapter, GD9106BNWP double junction gel-filled epoxy-body pH electrode, 927007MD stainless steel ATC temperature probe, 916099 pH buffer and solution kit	LSTAR1117
Orion Lab Star PH111 pH/mV bench meter difficult sample kit, includes meter with stand, PC cable, universal power adapter, 9165BNWP Sure-Flow refillable epoxy-body pH electrode, 927007MD stainless steel ATC temperature probe, 916099 pH buffer and solution kit	LSTAR1118
Orion electrode arm with meter-attached bracket for Orion Lab Star meters	LSTAR-ARM
Orion twist-and-lock universal 100-240V, 50/60Hz power adapter for Orion Lab Star meters	LSTAR-PWR
Orion USB computer cable for Orion Lab Star meters	LSTAR-USB
Orion dust cover for Orion Lab Star meters	LSTAR-CVR
Orion compact ink-ribbon printer for Orion Lab Star meters; 100-240V, 50/60Hz	STARA-106
Orion replacement ink ribbon for compact printer, 6 pack	STARA-108
Orion replacement paper for compact printer, 5 pack	STARA-109

### 9.2 Electrode and Solution Ordering Info

Description	Catalog Number
General purpose refillable pH electrode with chemically-resistant glass-body, BNC, 1m cable	9102BNWP
General purpose gel-filled pH electrode with durable epoxy-body, BNC, 1m cable	9106BNWP
General purpose refillable pH electrode with durable epoxy-body, BNC, 1m cable	9156BNWP
Double junction refillable pH electrode with chemically-resistant glass-body, BNC, 1m cable	9102DJWP
Double junction gel-filled pH electrode with durable epoxy-body, BNC, 1m cable	GD9106BNWP
Double junction refillable pH electrode with durable epoxy-body, BNC, 1m cable	GD9156BNWP
Triode gel-filled pH/ATC temperature electrode with epoxy-body, BNC and MiniDIN, 1m cable	9107BNMD
Triode polymer-filled pH/ATC temperature electrode with epoxy-body, BNC and MiniDIN, 1m cable	9107APMD
Triode refillable pH/ATC temperature electrode with epoxy-body, BNC and MiniDIN, 1m cable	9157BNMD

Description	Catalog Number
Sure-Flow refillable pH electrode with chemically-resistant glass-body, BNC, 1m cable	9172BNWP
Sure-Flow refillable pH electrode with durable epoxy-body, BNC, 1m cable	9165BNWP
ATC temperature probe, epoxy body, MiniDIN, 1m cable	927005MD
ATC temperature probe, stainless steel body, MiniDIN, 1m cable	927007MD
Triode refillable ORP/ATC temperature electrode with epoxy-body, BNC and MiniDIN, 1m cable	9180BNMD
Sure-Flow refillable ORP electrode with durable epoxy-body, BNC, 1m cable	9678BNWP
Standard All-in-One pH Buffer Kit: 475 mL each of pH 4.01, 7.00 and 10.01 buffers; 475 mL of pH electrode storage solution and electrode storage bottle	910199
All-in-One 60 mL pH Buffer Kit: 60 mL each of pH 4.01, 7.00 and 10.01 buffers; 60 mL of pH electrode storage solution and 60 mL of pH electrode cleaning solution	916099
pH Electrode Cleaning Kit – 30 mL each protein and general cleaning solutions, 60 mL each bacteria and oil cleaning solutions, beaker and pipet	900020
pH 1.68 buffer, 5 x 60 mL	9116860
pH 1.68 buffer, 475 mL	910168
pH 4.01 buffer, 5 x 60 mL	910460
pH 4.01 buffer, 475 mL	910104
pH 4.01 buffer, 19 L cubitainer	9104CB
pH 6.86 buffer, 5 x 60 mL	916860
pH 6.86 buffer, 475 mL	910686
pH 7.00 buffer, 5 x 60 mL	910760
pH 7.00 buffer, 475 mL	910107
pH 7.00 buffer, 19 L cubitainer	9107CB
pH 9.18 buffer, 5 x 60 mL	9191860
pH 9.18 buffer, 475 mL	910918
pH 10.01 buffer, 5 x 60 mL	911060
pH 10.01 buffer, 475 mL	910110
pH 10.01 buffer, 19 L cubitainer	9110CB
pH 12.46 buffer, 5 x 60 mL	911260-WA
pH 12.46 buffer, 475 mL	910112
Electrode storage solution, 5 x 60 mL	910060
Electrode storage solution, 475 mL	910001
Electrode storage solution, 19 L cubitainer	9100CB
ORP Standard, +420 mV standard hydrogen electrode EH, 5 x 60 mL	967961
ORP Standard, +420 mV standard hydrogen electrode EH, 475 mL	967901
Single junction silver-chloride pH and ORP electrode filling solution, 5 x 60 mL	900011
Double junction silver-chloride pH electrode filling solution, 5 x 60 mL	910008-WA
Electrode storage sleeve (12 mm diameter electrodes) with stand	810017

## Orion Lab Star PH111 pH/mV Meter



Scientists have trusted Thermo Scientific Orion Lab Products for over 60 years to provide them with accurate and reliable analytical testing instruments in the lab and in the field. Since 1962, Thermo Scientific Orion products have set the standard for quality in electrochemistry. We offer instruments for analytical and optical measurement that allow scientists to solve some of the most challenging issues facing society today. Whether online in the plant, in the field or in the lab, scientists trust Orion products deliver precise and accurate readings, which help you keep our communities healthier, cleaner, and safer.

Find out more at [thermofisher.com/electrochemistry](https://thermofisher.com/electrochemistry)

Contact us today at [wlp.techsupport@thermofisher.com](mailto:wlp.techsupport@thermofisher.com)

This product is intended for General Laboratory Use. It is the customer's responsibility to ensure that the performance of the product is suitable for customers' specific use or application. © 2022 Thermo Fisher Scientific Inc. All rights reserved. All trademarks are the property of Thermo Fisher Scientific and its subsidiaries unless otherwise specified. 68X002222 Rev 01 0622

**ThermoFisher**  
S C I E N T I F I C