

photoLab[®] 7600 UV-VIS

SPECTROPHOTOMETER



a xylem brand

Copyright

© 2022, Xylem Analytics Germany GmbH
Printed in Germany.

Contents

| | | |
|----------|--|-----------|
| 1 | Overview | 7 |
| 1.1 | Overview of the instrument | 7 |
| 1.2 | Keypad | 8 |
| 1.3 | Display | 9 |
| 2 | Safety | 11 |
| 2.1 | Safety information | 11 |
| 2.1.1 | Safety information in the operating manual | 11 |
| 2.1.2 | Safety signs on the product | 11 |
| 2.1.3 | Further documents providing safety information | 11 |
| 2.2 | Safe operation | 12 |
| 2.2.1 | Authorized use | 12 |
| 2.2.2 | Requirements for safe operation | 12 |
| 2.2.3 | Unauthorized use | 12 |
| 2.3 | User qualification | 12 |
| 2.4 | Handling of hazardous substances | 13 |
| 3 | Commissioning | 14 |
| 3.1 | Scope of delivery | 14 |
| 3.2 | General notes on handling | 14 |
| 3.3 | Initial commissioning | 15 |
| 3.3.1 | Inserting the buffer batteries | 15 |
| 3.3.2 | Connecting the power supply | 16 |
| 3.3.3 | Switching on the photometer for the first time | 16 |
| 3.3.4 | Setting the language | 17 |
| 3.3.5 | Setting the date and time | 18 |
| 3.4 | Connecting optional accessories | 19 |
| 3.4.1 | Communication interfaces | 19 |
| 3.4.2 | PC/printer | 20 |
| 3.4.3 | USB memory device | 20 |
| 3.4.4 | PC keyboard | 21 |
| 3.4.5 | Barcode reader | 21 |
| 3.4.6 | Operation with a 12 V vehicle connection cable | 21 |

| | | |
|----------|---|-----------|
| 4 | Operation | 23 |
| 4.1 | Switching on or off the photometer | 23 |
| 4.2 | General operating principles | 25 |
| 4.2.1 | Navigating with function keys and menus | 25 |
| 4.2.2 | Display of navigation paths in short form | 26 |
| 4.2.3 | Entry of numerals, letters and characters | 27 |
| 4.2.4 | Detailed operating example: Changing the language | 29 |
| 4.2.5 | Inserting a cell | 30 |
| 4.2.6 | Usable cells | 31 |
| 4.3 | Photometer settings and system administration | 32 |
| 4.3.1 | Language | 32 |
| 4.3.2 | Date/Time | 33 |
| 4.3.3 | Display settings | 34 |
| 4.4 | Zero adjustment | 34 |
| 4.5 | Measuring in <i>Concentration</i> mode | 38 |
| 4.5.1 | Measuring cell tests with barcode | 38 |
| 4.5.2 | Measuring reagent tests with AutoSelector | 39 |
| 4.5.3 | Measuring reagent-free tests and user-defined methods | 40 |
| 4.5.4 | Exceeding the upper or lower limits of the measuring range | 41 |
| 4.5.5 | Selecting a method manually | 41 |
| 4.5.6 | Settings for <i>Concentration</i> mode | 43 |
| 4.5.7 | Measuring diluted samples | 44 |
| 4.5.8 | Sample blank value | 45 |
| 4.5.9 | Reagent blank value | 47 |
| 4.5.10 | User calibration (standard adjustment) | 50 |
| 4.5.11 | Automatic Turbidity correction | 57 |
| 4.5.12 | Programming / modifying user-defined methods | 57 |
| 4.5.13 | The <i>IQ-LabLink</i> procedure | 67 |
| 4.6 | Measuring the Absorbance / % Transmission | 68 |
| 4.6.1 | General information | 68 |
| 4.6.2 | Measuring the absorbance or transmission | 68 |
| 4.6.3 | Measuring against the Reference absorbance | 69 |
| 4.7 | Special / Multi wavelengths methods | 71 |
| 4.7.1 | Basic information on Special / Multi wavelengths measurements | 71 |
| 4.7.2 | Programming / modifying the Special / Multi wavelengths methods | 72 |
| 4.7.3 | Selecting a Special / Multi wavelengths method | 78 |
| 4.7.4 | Carrying out Special / Multi wavelengths measurements | 79 |
| 4.8 | OptRF measurement | 82 |
| 4.8.1 | General information | 82 |
| 4.8.2 | Selecting OptRF measurement | 83 |
| 4.8.3 | Carrying out measurements | 84 |
| 4.8.4 | Setting the dilution | 87 |
| 4.8.5 | User calibration | 88 |
| 4.9 | Spectrum | 91 |
| 4.9.1 | General information | 91 |
| 4.9.2 | Recording the Spectrum | 92 |
| 4.9.3 | Loading/editing a spectrum | 94 |
| 4.9.4 | Saving / exporting a spectrum | 98 |

| | | |
|---------|--|-----|
| 4.10 | Kinetics | 99 |
| 4.10.1 | Creating/editing profiles for Kinetics recordings | 99 |
| 4.10.2 | Loading a profile for Kinetics recording | 102 |
| 4.10.3 | Recording the Kinetics | 103 |
| 4.10.4 | Saving / exporting a Kinetics record | 105 |
| 4.10.5 | Loading a Kinetics record | 106 |
| 4.10.6 | Editing a Kinetics record | 107 |
| 4.11 | Timer | 109 |
| 4.11.1 | <i>User defined timer</i> | 110 |
| 4.11.2 | Analysis timer | 110 |
| 4.12 | Memory | 112 |
| 4.12.1 | Overview | 112 |
| 4.12.2 | Instructions on using USB memory devices | 114 |
| 4.12.3 | Measurement datasets | 114 |
| 4.12.4 | Saving measurement datasets manually | 115 |
| 4.12.5 | Saving measurement datasets automatically | 116 |
| 4.12.6 | Displaying measurement data memory | 117 |
| 4.12.7 | Filtering measurement datasets | 118 |
| 4.12.8 | Inverting filters | 120 |
| 4.12.9 | Erasing stored measurement datasets | 121 |
| 4.12.10 | Saving kinetic recordings, spectra and AQA files | 122 |
| 4.12.11 | Saving data as a pdf file | 122 |
| 4.13 | Ethernet interface | 123 |
| 4.13.1 | Integrating the photometer into an existing network (e.g. company network) | 123 |
| 4.13.2 | Connecting the photometer directly to the PC | 126 |
| 4.14 | Data transfer (PC software photoLab® Data <i>spectral</i>) | 129 |
| 4.15 | Backup or export data | 129 |
| 4.15.1 | Copying all measurement data files to a USB memory device | 130 |
| 4.15.2 | Copying user-defined methods / profiles to a USB memory device | 131 |
| 4.15.3 | Accessing photometer files via a FTP connection | 133 |
| 4.16 | Importing files | 134 |
| 4.16.1 | Importing spectra or kinetic recordings from a USB memory device | 134 |
| 4.16.2 | Importing methods / profiles from a USB memory device | 134 |
| 4.16.3 | Importing files from a PC | 135 |
| 4.17 | Printing the data (USB) | 136 |
| 4.17.1 | Printer and terminal programs | 136 |
| 4.17.2 | Settings for data transmission | 136 |
| 4.17.3 | Printing measurement datasets | 137 |
| 4.17.4 | Printing spectra or Kinetics records | 138 |
| 4.18 | Analytical quality assurance (AQA) | 138 |
| 4.18.1 | General information | 138 |
| 4.18.2 | Photometer monitoring (AQA1) | 138 |
| 4.18.3 | Total system monitoring (AQA2) | 143 |
| 4.18.4 | AQA3/MatrixCheck | 147 |

| | | |
|----------|---|------------|
| 4.19 | User management | 153 |
| 4.19.1 | User levels and user rights | 153 |
| 4.19.2 | Activating or deactivating the User management function | 154 |
| 4.19.3 | Creating, changing or deleting a user account | 155 |
| 4.19.4 | Login with active user management | 157 |
| 4.19.5 | Changing the password | 158 |
| 4.20 | Reset | 159 |
| 4.21 | Photometer information ([Info]) | 160 |
| 4.22 | Lamp counter | 160 |
| 4.23 | Software and methods update | 161 |
| 5 | Maintenance and cleaning | 163 |
| 5.1 | Exchanging the buffer battery | 163 |
| 5.2 | Cleaning | 164 |
| 5.2.1 | Cleaning the enclosure | 164 |
| 5.2.2 | Cleaning the cell shaft | 164 |
| 5.2.3 | Cleaning the detector lens | 165 |
| 6 | What to do if... | 166 |
| 6.1 | Actions in the case of a broken cell | 166 |
| 6.2 | Error causes and remedies | 167 |
| 7 | Technical data | 170 |
| 7.1 | Measurement characteristics | 170 |
| 7.2 | Measured value documentation and quality assurance | 173 |
| 7.3 | General meter data | 173 |
| 8 | Accessories and options | 176 |
| 8.1 | Accessories | 176 |
| 8.2 | Test equipment | 177 |
| 8.3 | Optional equipment | 177 |
| 8.4 | Connection cable: | 178 |
| | Appendix | 179 |
| A.1 | Glossary | 179 |
| A.2 | List of trademarks | 181 |
| 3 | Disposal | 182 |
| A.4 | Index | 184 |

1 Overview

1.1 Overview of the instrument

Front of the instrument

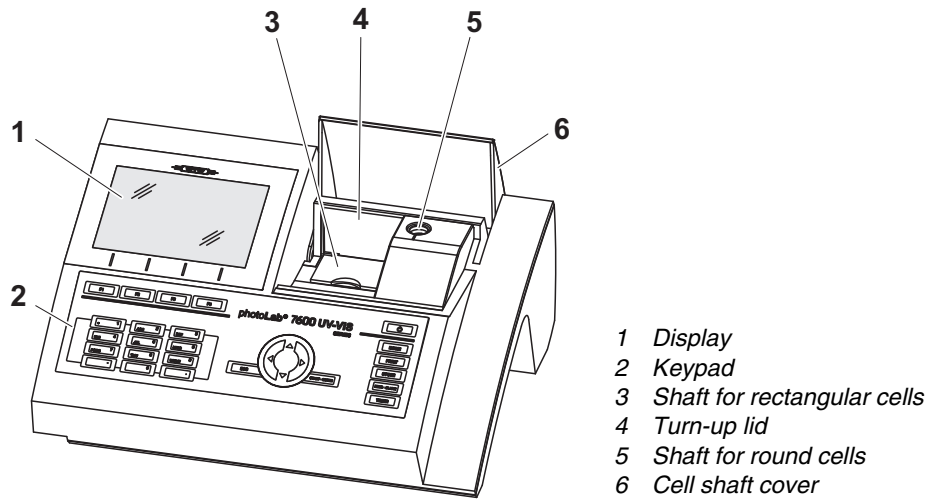

Fig. 1-1 Front of the instrument with operating elements

Socket field on the rear panel

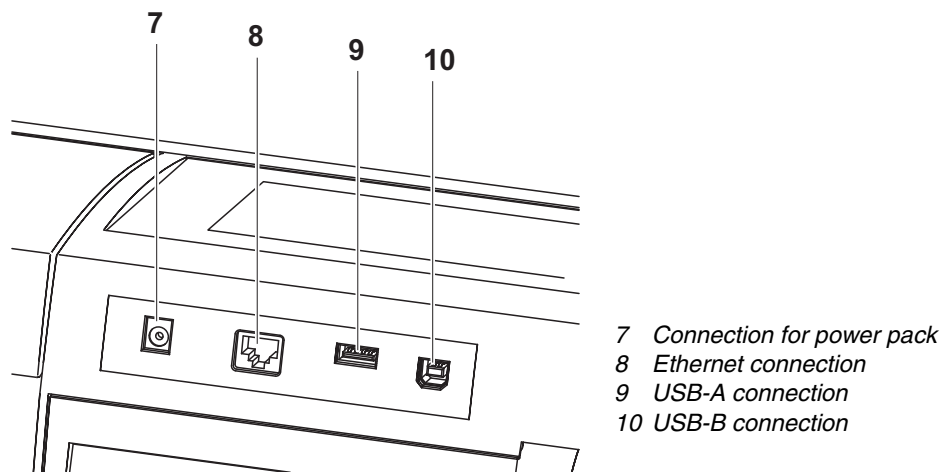

Fig. 1-2 Rear panel with socket field



All connections comply with SELV.

1.2 Keypad

Overview

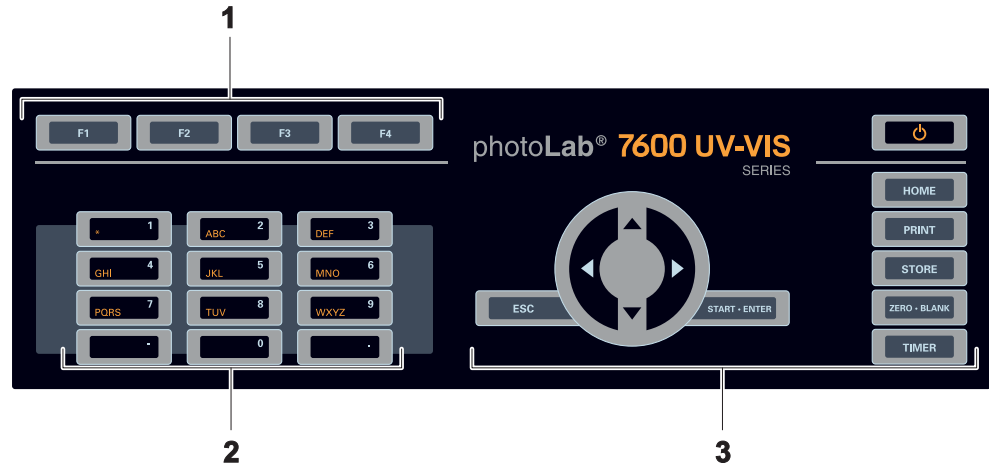









- 1 Function keys F1 to F4 (function menu-dependent)
- 2 Alphanumeric keypad
- 3 Keys with dedicated function

Fig. 1-3 Keypad

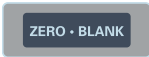
Key functions

The keys on the right side of the keypad have the following functions:

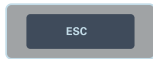
| Key | Designation | Functions |
|---|--------------|---|
|  | <ON/OFF> | – Switches on and off the photometer |
|  | <HOME> | – Switches to the main menu from any operating situation. Actions that are not completed are canceled. |
|  | <PRINT> | – Outputs the displayed measured value to an interface if the <i>Printer</i> symbol is displayed in the status line. |
|  | <STORE> | – Saves a displayed measured value or spectrum if the <i>Save</i> symbol is displayed in the status line. |
|  | <ZERO-BLANK> | – Starts one of the following measurements, depending on the operating situation: - Zero adjustment - Blank value measurement - Baseline measurement - User calibration |

| Key | Designation | Functions |
|---|---------------|--|
|  | <TIMER> | – Opens the menu, <i>Timer</i> . |
|  | <ESC> | – Cancels the running action. Entries that have not yet been accepted are discarded. – Switches to the next higher menu level. |
|  | <START-ENTER> | – Starts an action (e.g. measurement) – Opens a selected menu – Confirms a selection or entry |
|  (Arrow keys) | <▲> or <▼> | – Moves the selection in menus and lists one position up or down |
| | <◀> | – Deletes the character left of the cursor during character entries – Moves the cursor to the left in a spectrum or kinetic diagram |
| | <▶> | – Moves the cursor to the right in a spectrum or kinetic diagram |

Function keys

The function keys F1 to F4 have different functions depending on the operating situation. The current functions are displayed in the function key menu at the bottom edge of the display (see section 4.2.1).

1.3 Display

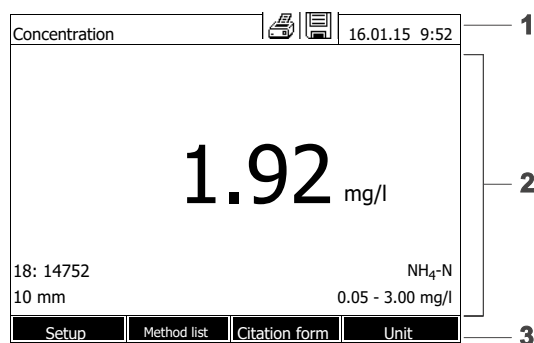

Display elements



- 1 Status line (current state, date and time)
- 2 Display range for menus and measurement results
- 3 Function keys menu

Fig. 1-4 Display

**Symbols in the
status line**

| Symbol | Designation | Function |
|---|--------------------|--|
|  | <i>Save</i> | The <STORE> key is active. You can store the displayed data with <STORE> (see section 4.12). |
|  | <i>Printer</i> | The <PRINT> key is active. You can output to an interface the displayed data with <PRINT> (see section 4.17). |

2 Safety

2.1 Safety information

2.1.1 Safety information in the operating manual

This operating manual provides important information on the safe operation of the product. Read this operating manual thoroughly and make yourself familiar with the product before putting it into operation or working with it. The operating manual must be kept in the vicinity of the product so you can always find the information you need.

Important safety instructions are highlighted in this operating manual. They are indicated by the warning symbol (triangle) in the left column. The signal word (e.g. "CAUTION") indicates the level of danger:



WARNING

indicates a possibly dangerous situation that can lead to serious (irreversible) injury or death if the safety instruction is not followed.



CAUTION

indicates a possibly dangerous situation that can lead to slight (reversible) injury if the safety instruction is not followed.

NOTE

indicates a situation where goods might be damaged if the actions mentioned are not taken.

2.1.2 Safety signs on the product

Note all labels, information signs and safety symbols on the product. A warning symbol (triangle) without text refers to safety information in this operating manual.

2.1.3 Further documents providing safety information

The following documents provide additional information, which you should observe for your safety when working with the measuring system:

- Operating manuals of other components of the photoLab® 7600 UV-VIS (accessories)
- Safety datasheets for chemicals.

2.2 Safe operation

2.2.1 Authorized use

The authorized use of the photometer consists exclusively of the carrying out of photometric measurements according to this operating manual. Follow the technical specifications of the cells in chapter 7 TECHNICAL DATA. Any other use is considered **unauthorized**.

2.2.2 Requirements for safe operation

Note the following points for safe operation:

- The product may only be operated according to the authorized use specified above.
- The product may only be supplied with power by the energy sources mentioned in this operating manual.
- The product may only be operated under the environmental conditions mentioned in this operating manual.
- The product may not be opened.

2.2.3 Unauthorized use

The product must not be put into operation if:

- it is visibly damaged (e.g. after being transported)
- it was stored under adverse conditions for a lengthy period of time (storing conditions, see chapter 7 TECHNICAL DATA).

2.3 User qualification

Carrying out photometric determinations with the aid of test sets frequently requires the handling of hazardous substances.

We assume that the operating personnel know how to handle hazardous substances due to their professional training and experience. The operating personnel must particularly be able to understand and correctly implement the safety labels and safety instructions on the packages and inserts of the test sets.

2.4 Handling of hazardous substances

When developing test sets, WTW carefully sees that the tests can be carried out as safely as possible. Some hazards by dangerous substances, however, cannot always be avoided.

If self-produced tests or solutions are used, the responsibility concerning any risks caused by those tests or solutions lies with the user (personal responsibility).



WARNING

Improper handling of certain reagents can cause damage to your health.

In any case follow the safety labels on the packing and the safety instructions of the package insert. Protective measures specified there have to be followed exactly.

Safety datasheets

The safety datasheets of the chemicals comprise all instructions on safe handling, occurring hazards, preventive actions and actions to take in hazardous situations. Follow these instructions in order to work safely.

3 Commissioning

3.1 Scope of delivery

- Spectrophotometer photoLab® 7600 UV-VIS
- Power pack with connection cable
- Buffer batteries 4 x AA alkaline manganese (Mignon)
- Zero cell (16 mm, round)
- Short instructions
- CD-ROM with
 - Detailed operating manual
 - Analysis instructions
 - SpectralTransfer software

Packing

This photometer is sent out in a protective transport packing.



CAUTION

Keep the original packing including the inner packing to protect the instrument against hard shocks if it has to be transported.

The original packing is also required for the proper return of the instrument if it has to be repaired.

Note that damage caused by improper transport voids all warranty claims.

3.2 General notes on handling

Always protect the meter from conditions that could damage the mechanical, optical and electronic components. Heed the following points especially:

- The temperature and humidity during operation and storage must be within the limits specified in chapter 7 TECHNICAL DATA.
- The following influences always have to be avoided with the meter:
 - Extreme dust, moisture and wetness
 - Exposure to intensive light and heat
 - Fumes that are corrosive or contain high concentrations of solvents.
- For measuring, the meter must be placed on a flat surface.
- Spilled liquid or other material should be removed immediately (see section 5.2 CLEANING or section 6.1 ACTIONS IN THE CASE OF A BROKEN CELL).
- The cell shaft should always be closed when the photometer is not used.
- For the instrument to be transported the cell shaft has to be empty.
- For mobile used we recommend using the suitable transport case FC spectral 6000 (see section 8.1 ACCESSORIES).

3.3 Initial commissioning

Perform the following activities:

- Insert the buffer batteries (see section 3.3.1)
- Connect the power supply (see section 3.3.2)
- Switch on the photometer (see section 3.3.3)
- Set the language (see section 3.3.4)
- Set the date and time (see section 3.3.5)
- Carry out a zero adjustment (see section 4.4)



When you set the language, date and time according to the sections 3.3.4 and 3.3.5 of this operating manual you will quickly become familiar with the simple operation of the photoLab® 7600 UV-VIS. More detailed instructions on operation are given in section 4.2 GENERAL OPERATING PRINCIPLES.

3.3.1 Inserting the buffer batteries

Four buffer batteries (type AA or Mignon, included in the scope of delivery) supply the integrated clock with power while the photometer is switched off.

Insert the batteries as follows:

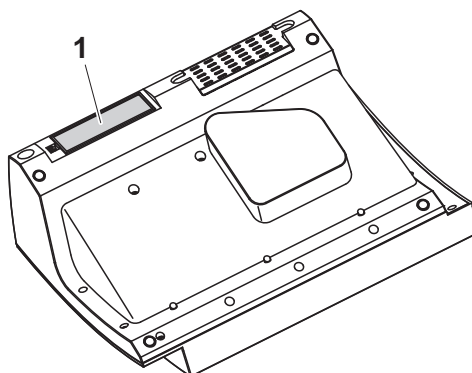

- 1 Turn the photometer upside down and place it on a soft surface.
- 2 Open the lid of the battery compartment (1).
- 3 Insert the four batteries in the battery compartment. Make sure that the poles of the batteries are in the correct position.
- 4 Close the lid of the battery compartment.

Battery service life

The power consumption of the clock is very low. The lifetime of high quality batteries is at least 5 years.

3.3.2 Connecting the power supply

The power is supplied with the aid of the enclosed plug-in power pack. The power pack supplies the photometer with low voltage (12 VDC).



CAUTION

The line voltage of the usage location must fulfill the specifications stated on the power pack (the specifications are also given in chapter 7 TECHNICAL DATA). Always use the supplied 12 V original power pack. Before plugging in the power cable check whether it is undamaged. If the power cable is damaged, the instrument must not be operated.

Connect the power pack

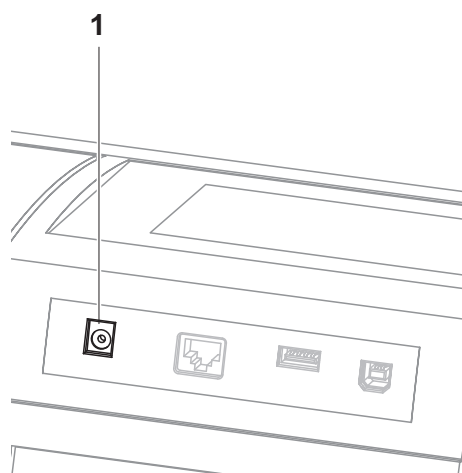

- 1 Connect the miniplug of the power pack to the socket (1) of the photometer.
- 2 Connect the power pack to a power outlet.

The display illumination switches itself on and then off again.

Operation with a mobile 12 V power source

You can also operate the photoLab® 7600 UV-VIS on the move and independent of the local power supply.

To do so, a 12 V power supply unit such as a commercial 12 V power station or a 12 V car battery and a 12 V vehicle connection cable is required (see section 3.4.6).

3.3.3 Switching on the photometer for the first time

During the initial commissioning, the photometer automatically guides you through the setting of the meter language, date and time after switching on (see following sections).

| | |
|------------------------|---------------|
| Language | 16.01.15 9:52 |
| German | |
| ✓ English | |
| Français | |
| Español | |
| Italiano | |
| Bulgarian/Български | |
| Česko | |
| Simplified Chinese/ 中 | |
| Traditional Chinese/ 繁 | |
| Greek/Ελληνικά | |

1 Press <ON/OFF>.

The photometer is switched on.

The display switches to the setting of the language (see section 3.3.4).

After the setting of the language the photometer carries out the self-test.

When the initial commissioning is completed, the photometer displays the *Home* menu each time after it is switched on and after the self-test (see section 4.1).

3.3.4 Setting the language

During the initial commissioning the photometer automatically guides you to the setting of the meter language after switching on.

| | |
|------------------------|---------------|
| Language | 16.01.15 9:52 |
| German | |
| ✓ English | |
| Français | |
| Español | |
| Italiano | |
| Bulgarian/Български | |
| Česko | |
| Simplified Chinese/ 中 | |
| Traditional Chinese/ 繁 | |
| Greek/Ελληνικά | |

1 Select a language with <▲ ><▼ >.

2 Confirm the selected language with <START·ENTER>.

The language has been set.

The currently selected language has a checkmark.

The display switches to the setting of the *Date* and *Time* (see section 3.3.5).

After the initial commissioning, you can change the language in the *General setup / Language* menu at any time (see section 4.2.4).

3.3.5 Setting the date and time

During the initial commissioning, the instrument automatically guides you to the setting of the time and date after the setting of the language.

| | |
|-----------|---------------|
| Date/Time | 16.01.15 9:52 |
| Date | 16.01.2015 |
| Time | 9:52:09 |
| OK | |

The *Date/Time* menu is open.

Using <▲ ><▼ >, select a menu item and confirm or open it with <START-ENTER>.

- 1 Select and confirm *Date*.

The input field for the current date pops up.

| | |
|-----------|---------------|
| Date/Time | 16.01.15 9:52 |
| Date | 16.01.2015 |
| Time | 9:52:09 |
| OK | |

Date
 16 .01.2015

- 2 Enter the current date with <0...9> and confirm.

The input field closes.
The date is accepted.

- 3 Select and confirm *Time*.

The input field for the current time pops up.

| | |
|-----------|---------------|
| Date/Time | 16.01.15 9:52 |
| Date | 16.01.2015 |
| Time | 9:52:09 |
| OK | |

Time
 09 : 52 : 09

- 4 Enter the current time with <0...9> and confirm.

The input field closes.
The time is accepted.

After the initial commissioning, you can change the date and time in the *General setup / Date/Time* menu at any time (see section 4.2.4).

3.4 Connecting optional accessories

3.4.1 Communication interfaces

Connections

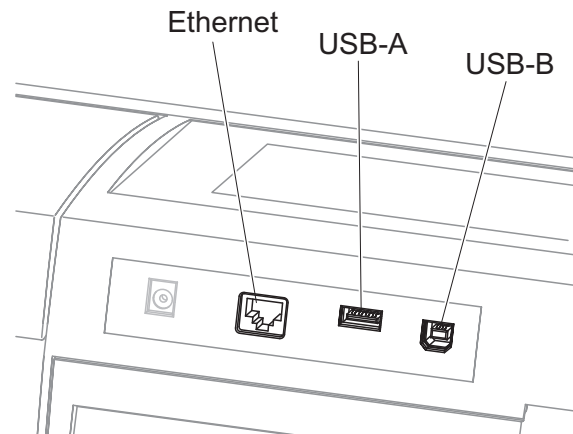

Fig. 3-1 Communication interfaces on the rear panel

You can connect the following accessories to the photometer:

- PC (see section 3.4.2)
- Printer (see section 3.4.2)
- USB storage media (see section 3.4.3)
- USB-PC keyboard (see section 3.4.4)
- Barcode reader (see section 3.4.5)
- 12 V vehicle charging cable (see section 3.4.6)



The number of USB-A sockets can be increased with a commercially available USB-2 hub with separate power supply.

3.4.2 PC/printer

PC and printer can be connected to the photometer as follows:

| Interface | PC | Printer | Functions |
|-----------|----|---------|---|
| USB-A | | ✓ | Print data (see section 4.17) Update the photometer software (see section 4.23). |
| Ethernet | ✓ | - | Transmit measurement data to the PC (see section 4.13) |



Suitable are PCL compatible printers (for details, see section 4.17.1 PRINTER AND TERMINAL PROGRAMS).

3.4.3 USB memory device

Using a USB memory device (such as a USB flash drive), you can

- Update the meter software and method data (section 4.23)
- transmit data to the USB memory device (section 4.12 and section 4.14).

USB memory devices are connected to the USB-A interface.



Please follow the instructions on using USB memory devices (see section 4.12.2).

3.4.4 PC keyboard

With the PC keyboard it is possible to enter letters, e.g. to assign names for identification (ID).

In addition, the following keys of the PC keyboard are assigned with the following functions of the photometer:

| Photometer | PC keyboard |
|--|-----------------------------------|
| <START·ENTER> | Enter |
| <ESC> | Esc |
| <F1> to <F4> (function keys) | F1 to F4 |
| <▲ ><▼ ><◀ ><▶ > (arrow keys) | Arrow keys |
| <HOME> | F5 |
| <PRINT> | F6 |
| <STORE> | F7 |
| <ZERO·BLANK> | F8 |
| <TIMER> | F9 |
| <ON/OFF> | F12 |
| Symbols and characters according to the operating manual | Corresponding key on the keyboard |
| 0..9 | 0..9 |
| - | - |
| . | . |

The USB-PC keyboard is connected to the USB-A interface.

3.4.5 Barcode reader

The barcode reader enables the simplified entering of alphanumeric character strings and can be used in all operating situations that require the entry of text or numerals. The barcode reader is connected to the USB-A interface.



Before using the bar code reader with the photometer, configure the bar code reader to use code 39 (see operating manual of your bar code reader).

3.4.6 Operation with a 12 V vehicle connection cable

With a commercial 12 V vehicle connection cable, you can operate the photoLab® 7600 UV-VIS spectrophotometer on the move and independent of the local power supply.

To do so, a 12 V power supply such as a commercial 12 V portable power source or a 12 V car battery is required.

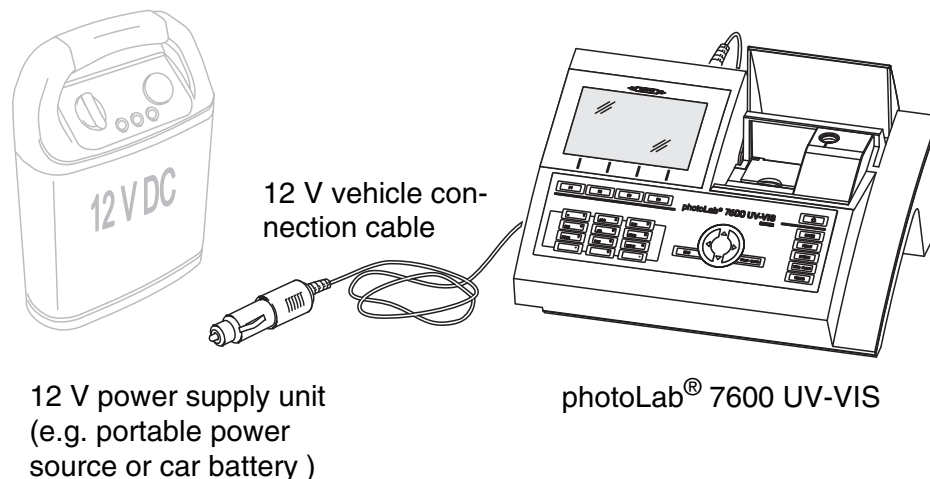

Safety

For operation with an external battery, follow the safety instructions of the battery.

Make sure the power source is suitable for operation of the spectrophotometer (see technical data of the power source and technical data of the spectrophotometer).

Operating time with battery

The maximum operating time depends on various factors:

- Battery (e.g. nominal capacity, condition, age)
- Operating mode of the spectrophotometer (e.g. frequency of measurements)
- Photometer (instrument type)

Example

Operating time with a type 12 V / 19 Ah battery in optimum condition: approx. 16 h



The spectrophotometer consumes electricity even while it is in standby mode.

With battery operation, we recommend you disconnect the vehicle connection cable while you are not using the photometer.

12 V vehicle connection cable

Vehicle connection cables with the following characteristics are suitable:

| | |
|------------------------------------|-------------|
| Voltage | 12 V |
| Amperage | 8 A |
| Barrel connector | 2.5 x 5.5mm |
| Positive pole at the inner contact | |

4 Operation

4.1 Switching on or off the photometer

Switching on

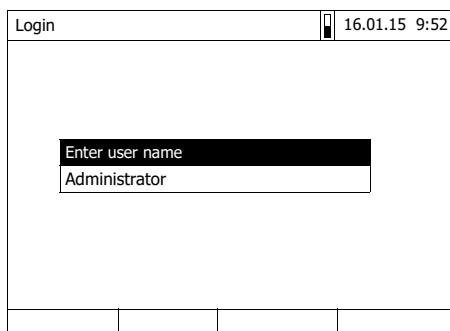
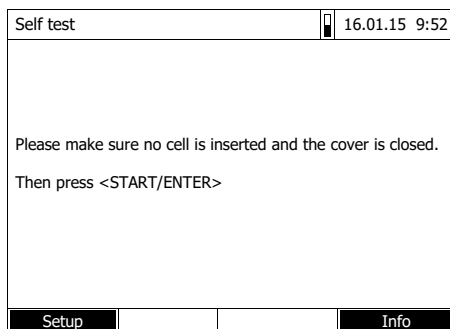

Starting the *Self test*

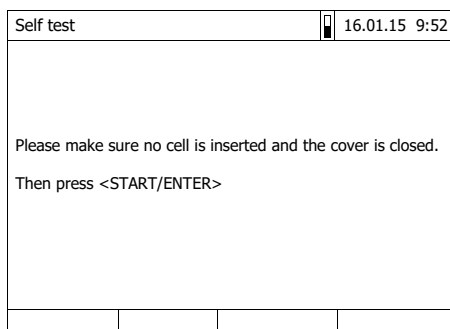

Self test

During the self-test, all cells must be removed and the cell shaft cover closed.

- 1 Switch the photometer on with **<ON/OFF>**.

The display shows

- the *Self test* dialog (if the user management is not active).

or

- the *Login* dialog (if the user management is active).

With activated user management:

- 2 Login

Enter user name and password or register as a guest (see section 4.19.4).

Then the photometer displays the *Self test* dialog.

- 3 Remove all cells and close the cell shaft cover.

- 4 Start the self-test with **<START·ENTER>**.

The photometer carries out the self-test.

The self-test runs in the background and may take some minutes.

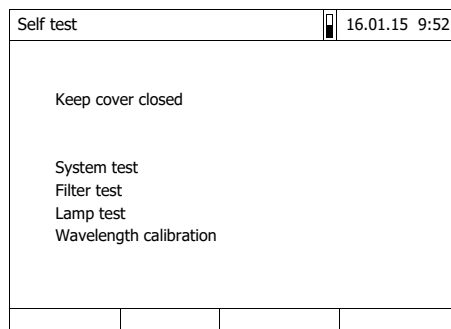

The self-test includes:

- the test of the memory, processor, internal interfaces, filter and lamp
- a calibration for each wavelength

After the self-test is completed, the main menu is displayed.



The result of the self-test can be viewed and printed with the *[Info]* function key (see section 4.21).

Automatic wavelength calibration

With the automatic wavelength calibration, the photometer checks and calibrates the accuracy of the wavelengths created (by the monochromator).

The wavelength calibration of the photometer takes place regularly after the photometer was switched on (within the framework of the self-test) and is automatically repeated during operation after 15, 30, 60, 120 and 240 minutes.

While the automatic wavelength calibration is running on the photometer, a note is displayed. The automatic wavelength calibration only starts if the cell shaft is empty.

If a cell is in the cell shaft the wavelength calibration is carried out only after the cell was removed.

Switching off

To switch the photometer off, keep the **<ON/OFF>** key depressed until the photometer is switched off.

4.2 General operating principles

4.2.1 Navigating with function keys and menus

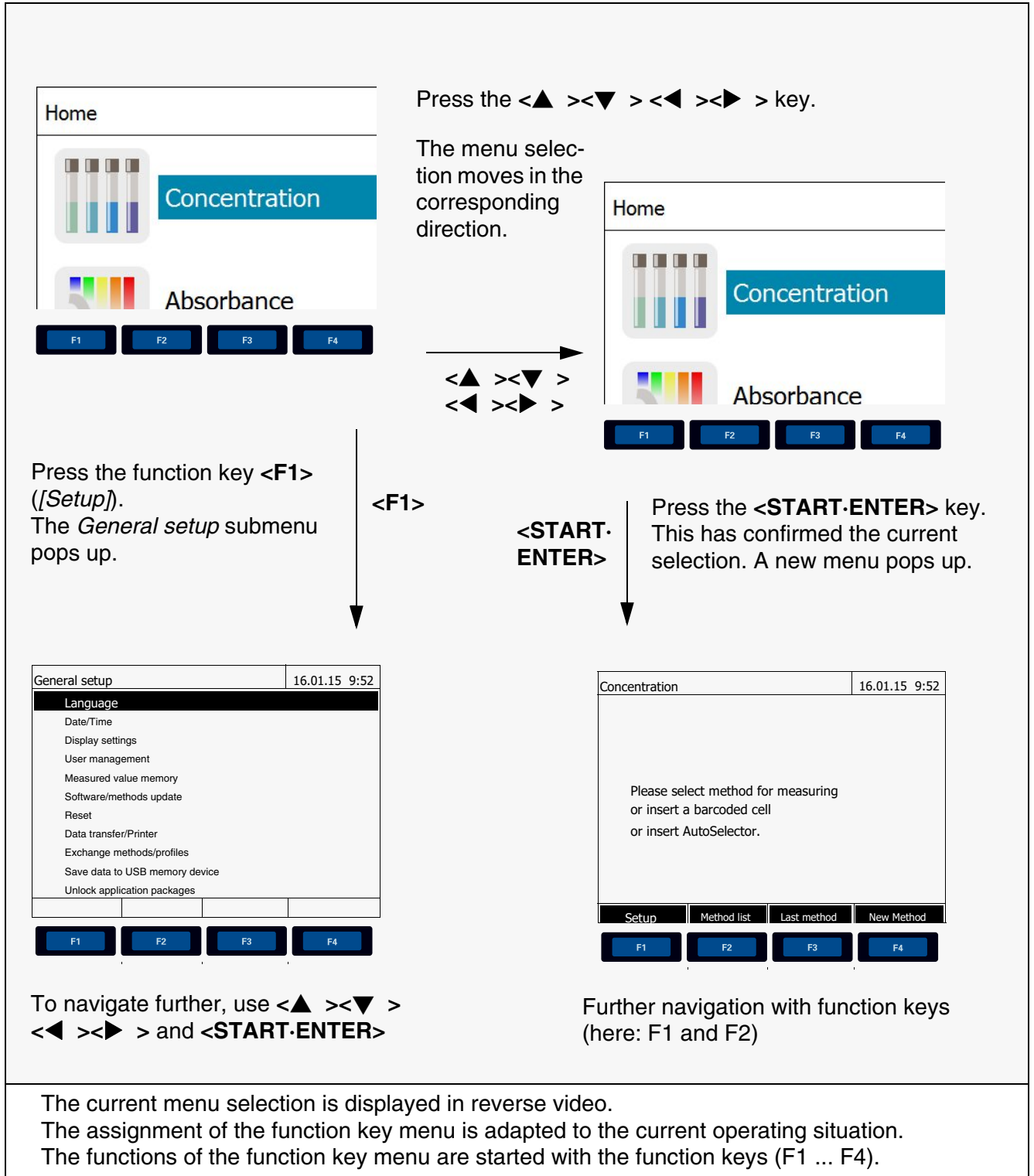

Use of the function keys

The function keys F1 to F4 are below the display. Their functions change depending on the operating situation and mode. The current functions are displayed in the function key menu at the bottom edge of the display.

Apart from navigation, the function keys are also used for other operations:

- Opening a selection list or input field
- Executing a command (directly or with intermediate query)
- Switching over between two display options, such as absorbance ↔ transmission

Navigation with arrow keys (<▲><▼><◀><▶>) and <START·ENTER>

These operating elements are used to select an item from a menu or list. The current selection is displayed in reverse video. Pressing of <START·ENTER> confirms the selection.

Apart from navigation, the <START·ENTER> key is also used for other operations:

- Opening a selection list or input field
- Confirming a selection
- Confirming entries of text and numerals
- Executing a command (directly or with intermediate query)
- Activating an item in a selection list (✓ = active)

4.2.2 Display of navigation paths in short form

In this operating manual, the introductory navigation steps leading to individual menus or dialogs are clearly shown in a gray box. The box indicates a section of the menu tree.

Starting point of the description is always the main menu, which can be reached with the <HOME> key from any operating situation. From there navigation takes place downward.

**Operating example:
Navigation to the setting menu for the language**

The following example shows the elements of the menu tree with the relevant

operating steps:

```
<HOME>
[General setup]
├─ Language
```

In this operating manual, bold letters and angle brackets indicate a key on the photometer (except function keys).

∅ Press the "Home" key.
The main menu is called up.

Square brackets in this operating manual indicate a function key F1 to F4. The text between the brackets corresponds to the assignment according to the function key menu on the bottom edge of the display.

∅ Press the function key with the assignment "Settings"

Text without brackets stands for a menu item indicated on the display (list item) in this operating manual.

∅ Select the menu item with the arrow keys <▲ ><▼ >. The current selection is displayed in reverse video.

∅ Then press <START·ENTER>.

Further navigation options:

- The <ESC> key moves one level up in the menu tree.
- The <HOME> key directly calls up the main menu.



If you are "lost" in a menu, press <HOME> and restart navigating from the main menu.

4.2.3 Entry of numerals, letters and characters

Numerals, letters, punctuation marks and special characters are entered with the alphanumeric keypad of the meter or using an external keyboard that can

be connected to the instrument via the USB-A interface.

Character set

The following characters are available:

- Numerals 0 ... 9
- Letters A ... Z and a ... z
- Punctuation marks. -
- Special characters ° / + Δ Σ μ # %:()

Operating principle



Entering characters is always possible if there is an input field on the display.

The numerals and characters (except for the small letters) assigned to the keys of the alphanumeric keypad are printed on the keys. Example: With the <7/PQRS> key you can enter the following characters: 7, P, Q, R, S, p, q, r, s.

Select the required character by pressing the key several times (similar to a mobile phone). When pressing a key that is assigned to several characters once, the respective numeral appears first. To enter a numeral, one keypressing is always sufficient.

When pressing the key for the first time a line pops up that displays all characters possible with this key. The currently selected character is highlighted.

A character is taken over in the input field if

- the character is highlighted for more than one second,
- the character is confirmed with <START·ENTER>,
- another alphanumeric key is pressed.



During mere number entries (such as entering a wavelength), the keys of the alphanumeric keypad are assigned to the respective numeral only. Each keypressing directly enters the numeral (like a pocket calculator).

Special characters

Special characters are entered with the <1/*> key.

Operating example: Entering the ID

The *Enter ID* input field appears if you press the <STORE> key while the storing symbol is visible. In the following example a measurement dataset with

the ID "Test" is stored.

| |
|----------|
| Enter ID |
| 8 |
| 8 TUVtuv |

| |
|------------|
| Enter ID |
| T |
| 8 T TUVtuv |

| |
|----------|
| Enter ID |
| Test_ |

- 1 Press **<8/TUV>** several times until "T" appears in the input line.

Below the input field, a selection line pops up with all characters that are available for this key, e.g. *8 TUVtuv*.

The currently selected character is highlighted.

After approx. one second the character is taken over and the selection line closed.

- 2 Complete the ID with **<A...9>** and confirm.

Correcting incorrect entries

Using **<◀ >**, erase all characters until you have reached the incorrect digit and repeat the entry from there.

4.2.4 Detailed operating example: Changing the language

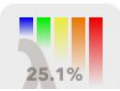
| | |
|---|------------------------------|
| Home | |
|  | Concentration |
|  | Absorbance % Transmission |
| General setup 16.01.15 9:52 | |
| Language | |
| Date/Time | |
| Display settings | |
| User management | |
| Measured value memory | |
| Software/methods update | |
| Reset | |
| Data transfer/Printer | |
| Exchange methods/profiles | |
| Save data to USB memory device | |
| Unlock application packages | |

- 1 Call up the main menu with the **<HOME>** key.
- 2 Open the *General setup* menu with the F1 function key [*Setup*].
- 3 Using **<▲ ><▼ >**, select the *Language* menu item and open with **<START·ENTER>**.

The *Language* menu shows a list with the available languages. The currently active language is marked by a tick.



4 Select the required language from the list with <▲ ><▼ > and confirm with <START·ENTER>.

The selected language is taken over immediately. The photometer moves up one menu level.

4.2.5 Inserting a cell

Round cells (with and without barcode)

Inserting a cell with barcode starts the measurement; with methods without barcode you have to select the method (see section 4.5.5 SELECTING A METHOD MANUALLY).

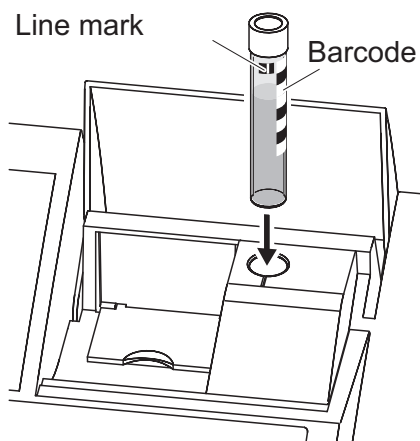

- 1 Open the cell shaft cover.
- 2 Close the inner turn-up lid.
- 3 Insert the barcoded round cell in the round cell shaft so it touches the bottom. When doing so, align the line mark with the notch at the front of the round cell shaft.

The photometer selects the method based on the bar code and automatically starts measurement.

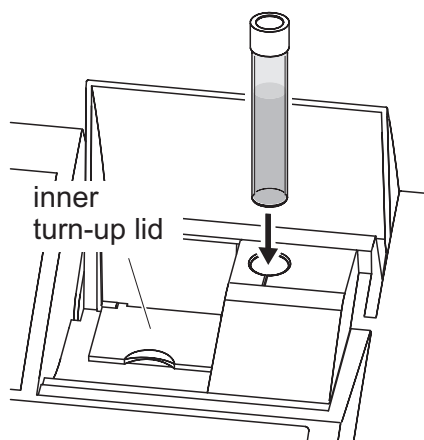

With cells without barcode: Select the method manually in the instrument.

Close the inner turn-up lid.

Insert the round cell in the round cell shaft so that it touches the bottom.



If the inner turn-up lid is opened too wide, a message prompts you to close the inner turn-up lid.

Rectangular cells (with or without AutoSelector)

The AutoSelector, which is included in the test sets for rectangular cells, has on one side a bar code encoding a method number. When the AutoSelector is inserted in the round cell shaft, the bar code is automatically read and the relevant method selected by the photometer. User-defined methods and reagent-free methods normally do not have an AutoSelector and therefore, no automatic method recognition. In this case, select the method manually (see section 4.5.5 SELECTING A METHOD MANUALLY) and then insert the cell.

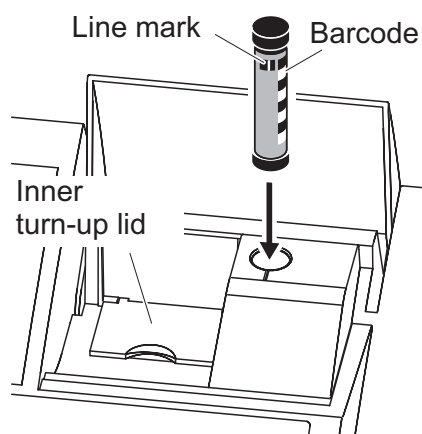

- 1 Open the cell shaft cover.
- 2 Insert the AutoSelector in the round cell shaft so it touches the bottom. When doing so, align the line mark with the notch at the front of the round cell shaft.
 - The photometer selects the correct method with the aid of the barcode.

With methods without AutoSelector: Select the method manually in the instrument.

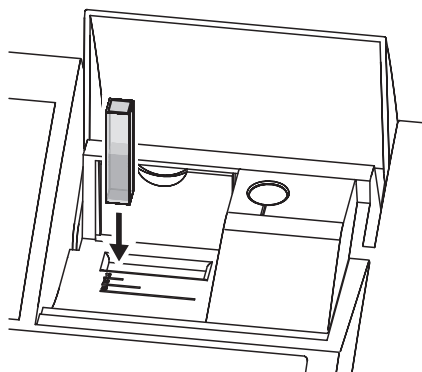

- 3 Open the inner turn-up lid.
- 4 Insert the rectangular cell vertically so it touches the bottom and left edge of the cell shaft. The opaque sides of the rectangular cell must point to the front and back.

If an AutoSelector is used, the correct measuring range is automatically selected when the rectangular cell (1, 2, 5 cm) is inserted.

The photometer has an external light recognition. If there is too much external light, a message prompts you to close the cell shaft cover.

4.2.6 Usable cells

Depending on the wavelength range, different kinds of cells are suitable.

Apart from round cells, all rectangular cells made of glass, quartz or plastic with opaque lateral surfaces are suitable (see section 8.1). Cells with clear or serrated lateral surfaces are not reliably recognized by the automatic cell recognition.

Especially with plastic single-use cells we recommend you test them for suitability prior to carrying out large-scale series of measurements.

For measurements in the UV range below 320 nm, glass cells and commercial PS plastic cells are not suitable; below 280 nm, commercial PMMA plastic cells are not suitable due to their transmission characteristics. Therefore, use quartz cells or tested single-use cells (plastic) for applications in the UV range.



Details on the minimum filling level and minimum filling volume are given in chapter 7 TECHNICAL DATA.

4.3 Photometer settings and system administration

The general photometer settings are done in the <HOME> -> *General setup* menu. These comprise:

- Language (see section 4.3.1)
- Date/time (see section 4.3.2 and section 4.2.4)
- Display characteristics (see section 4.3.3)
- User management (see section 4.19)
- Administration of the measurement data memory (see section 4.12)
- Software and method update (see section 4.23)
- Reset of the settings to default values (see section 4.20)
- Settings for data transmission (see section 4.17.2)

4.3.1 Language

The complete list of the available instrument languages is given in the *Language* chapter and in chapter 7 TECHNICAL DATA menu of the photometer.



How to set the language is described in detail in the operating example in section 4.2.4.

4.3.2 Date/Time

The date format is set automatically with the language setting. According to the locally usual version, the date format is displayed in the order, Day.Month.Year (*DD.MM.YY*) or Month/Day/Year (*MM/DD/YY* or *MM.DD.YY*).

```
<HOME>
[General setup]
└─ Date/Time
```

The *Date/Time* menu is open.

1 Select and confirm *Date*.

The input field for the current date pops up.

| | |
|---|---------------|
| Date/Time | 16.01.15 9:52 |
| Date | 16.01.2015 |
| Time | 9:52:09 |
| <div style="border: 1px solid black; padding: 5px; margin: 10px 0;"> Date 16 .01.2015 </div> | |
| OK | |

2 Enter the current date with **<0...9>** and confirm.

The input field closes.
The date is accepted.

3 Select and confirm *Time*.

The input field for the current time pops up.

| | |
|--|---------------|
| Date/Time | 16.01.15 9:52 |
| Date | 16.01.2015 |
| Time | 9:52:09 |
| <div style="border: 1px solid black; padding: 5px; margin: 10px 0;"> Time 09 : 52 : 09 </div> | |
| OK | |

4 Enter the current time with **<0...9>** and confirm.

The input field closes.
The time is accepted.

4.3.3 Display settings

Here you can adjust the display brightness to the lighting conditions.

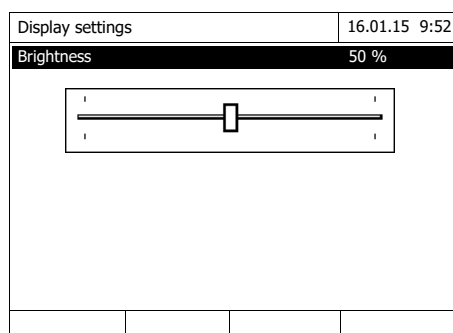
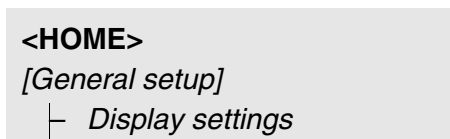

- 1 Select and confirm *Brightness*.
A slide control for the display brightness appears.
- 2 Set and confirm the display brightness with <◀ ▶▶ >.

4.4 Zero adjustment

A valid zero adjustment is required for the calculation of measured values in the modes, *Concentration*, *Absorbance / % Transmission*, *Special / Multi wavelengths* and *Kinetics*. With a zero adjustment, the absorbance of a cell filled with distilled water ("zero cell") is measured and stored as the zero value.

Factory zero adjustment for concentration measurements

For all measurements with WTW test sets (*Concentrationmode*), a factory zero adjustment is available in the delivery condition. We recommend replacing it with a zero adjustment of your own. If a zero adjustment exists already for a method, the date and time of the last zero adjustment are displayed in the top right area of the display.

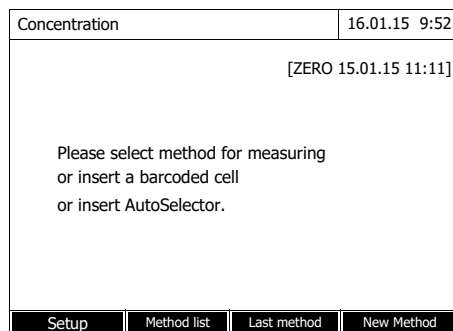

Zero adjustment for absorbance measurements

In the *Absorbance* mode, the zero adjustment has to be carried out separately for each cell type and each used wavelength. If a zero adjustment exists already for the inserted cell type at the selected wavelength, the date and time of the last zero adjustment are displayed in the top right area of the display.

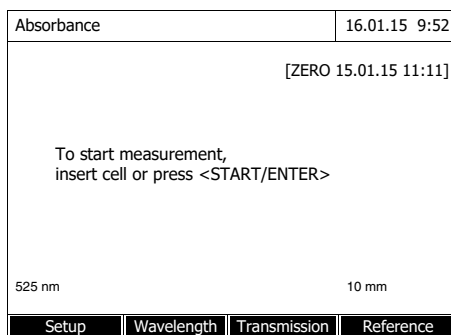

If no zero adjustment is available, the photometer will prompt you to carry out a zero adjustment.



The cells must be absolutely clean and free of scratches. Always use a cell of the same type for zero adjustment and measurement of the sample.

Notes on zero adjustment

Zero adjustment with round cells:

- Only use clean, scratch-free round cells with distilled water. The minimum filling level is 20 mm. A ready-filled zero cell is included in the scope of delivery of the photometer and PhotoCheck (see chapter 8 ACCESSORIES AND OPTIONS).
- A zero cell can, in principle, be used any number of times. Regularly check the zero cell for visible contamination and scratches. Refill or exchange it if necessary (at least every 24 months).

Zero adjustment with rectangular cells:

- For rectangular cells, the zero adjustment must be carried out with the same cell type (manufacturer and glass type [e.g. optical glass, quartz glass, plastic]) that is used for measurement. This is important because cells of different manufacturers have different absorption behavior. When changing the cell type repeat the zero adjustment with the new type.
- Prior to zero adjustment, clean the rectangular cell and fill it with distilled water. The minimum filling level is 20 mm.
- Rectangular cells always have to be inserted in the cell shaft with the same orientation for measurement and zero adjustment (e.g. cell printing on the left side).



Information on cells is provided in chapter 7 TECHNICAL DATA. Note that the spectral transparency of the cell must be suitable for the intended application (example, quartz cell for UV range).

Carrying out a zero adjustment

The zero adjustment takes place similarly in the *Concentration*, *Absorbance / % Transmission*, *Special / Multi wavelengths* and *Kinetics* modes.

- 1 In the respective mode, press the **<ZERO-BLANK>** key.
- 2 In *Concentration* mode only: Select and confirm *Zero adjustment*.

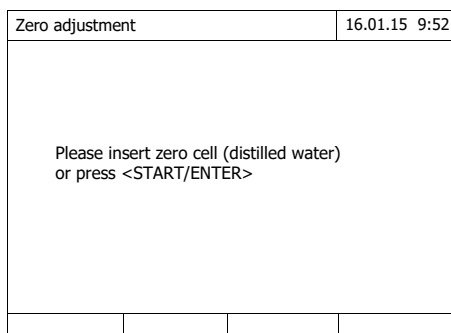
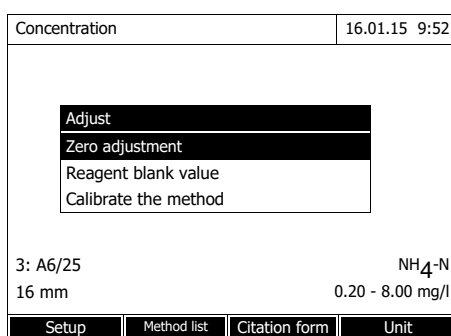

The zero adjustment window pops up.

- 3 Insert the zero cell (see section 4.2.5 INSERTING A CELL).

The photometer automatically starts the zero adjustment and subsequently stores the value.

- 4 After a successful zero adjustment switch to measurement with **[OK]**.

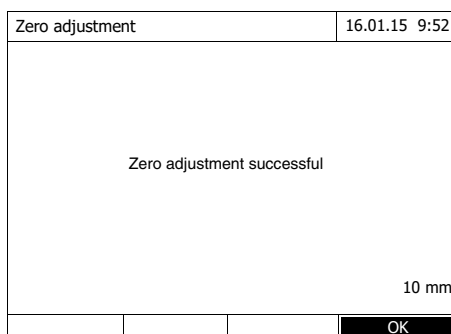

Validity of the zero adjustment

The data of the zero adjustment is stored in the photometer separately for each cell type. As long as the data is valid, it is automatically used again after a temporary change to a different cell type. The validity depends on the respective mode:

| Mode | Validity of the zero adjustment |
|---|---|
| <i>Absorbance / % Transmission</i> | <ul style="list-style-type: none"> ● Till the next zero adjustment with the same wavelength * |
| <i>Concentration (user-defined methods) and Special / Multi wavelengths</i> | <ul style="list-style-type: none"> ● Till the next zero adjustment for the same method * |
| <i>Kinetics</i> | <ul style="list-style-type: none"> ● Till another kinetic profile is loaded ● Till the <i>Kinetics</i> mode is exited or the photometer is switched off |

* The photometer displays that a zero adjustment is available and the time it was carried out. You can then decide whether to use this zero adjustment or carry out a new zero adjustment.

When to repeat the zero adjustment?

We recommend to repeat the zero adjustment in the following cases:

- If the photometer was subject to mechanical stress such as strong shock or transport
- If the ambient temperature changed by more than 5 °C since the last zero adjustment
- At least once per week
- If a new cell type (different manufacturer, different glass type is used)
- Basically each time you want to measure with the highest possible accuracy.

4.5 Measuring in *Concentration* mode

4.5.1 Measuring cell tests with barcode

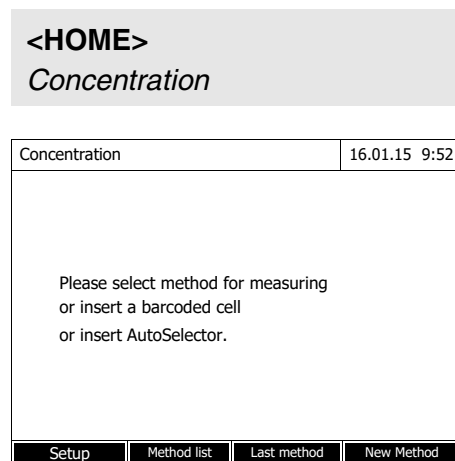

Inserting a cell with barcode starts a measurement.

- 5 Insert the barcoded round cell in the round cell shaft so it touches the bottom. When doing so, align the line mark with the notch at the front of the round cell shaft (see section 4.2.5 INSERTING A CELL).

The photometer selects the method based on the bar code and automatically starts measurement.

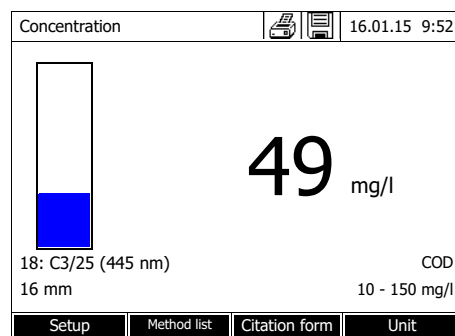

- 6 Further options:

- Select a different citation form with *[Citation form]*, (e.g. $\text{NH}_4 \leftrightarrow \text{NH}_4\text{-N}$).
- Select a different measuring unit with *[Unit]*, (e.g. $\text{mg/l} \leftrightarrow \text{mmol/l}$).
- Make further settings with *[Setup]* (see section 4.5.6).

4.5.2 Measuring reagent tests with AutoSelector

On one side, the AutoSelector has a bar code encoding a method number. When the AutoSelector is inserted in the round cell shaft, the bar code is automatically read and the relevant method selected by the photometer.

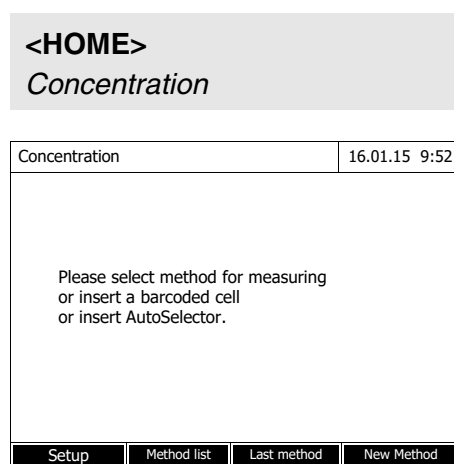

1 Open the cell shaft cover.

2 Insert the AutoSelector in the round cell shaft so it touches the bottom. When doing so, align the line mark with the notch at the front of the round cell shaft (see section 4.2.5 INSERTING A CELL).

- The photometer selects the correct method with the aid of the barcode.

3 Insert the rectangular cell (see section 4.2.5 INSERTING A CELL). The correct measuring range is automatically selected when the rectangular cell (1, 2, 5 cm) is inserted.

The photometer starts measuring automatically.

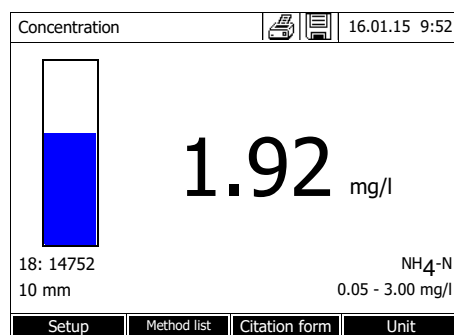

4 Further options:

- Select a different citation form with *[Citation form]*, (e.g. $\text{NH}_4 \leftrightarrow \text{NH}_4\text{-N}$).
- Select a different measuring unit with *[Unit]*, (e.g. $\text{mg/l} \leftrightarrow \text{mmol/l}$).
- Make further settings with *[Setup]* (see section 4.5.6).

4.5.3 Measuring reagent-free tests and user-defined methods

User-defined methods and reagent-free methods normally do not have a barcode and therefore, no automatic method recognition. In such a case, select the method manually:

<HOME>
Concentration

| | |
|--|---------------|
| Concentration | 16.01.15 9:52 |
| Please select method for measuring or insert a barcoded cell or insert AutoSelector. | |
| Setup | Method list |
| Last method | New Method |

- 1 Select the method manually (see section 4.5.5).

| | |
|---|------------------------------|
| Concentration | 16.01.15 9:52 |
| To start measurement, insert cell or press <START/ENTER> | |
| 15: Color436 (436 nm) | DFZ |
| 50 mm | 0.1 - 50.0 m ⁻¹ l |
| Setup | Method list |
| Citation form | Unit |

The photometer is ready to measure.

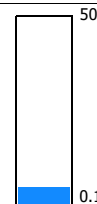
| | |
|---|------------------------------|
| Concentration | 16.01.15 9:52 |
|  | |
| 0.629 mg/l | |
| 15: Color436 (436 nm) | DFZ |
| 50 mm | 0.1 - 50.0 m ⁻¹ l |
| Setup | Method list |
| Citation form | Unit |

- 2 Insert the cell (rectangular or round) (see section 4.2.5 INSERTING A CELL).
- 3 Further options:
 - Select a different citation form with *[Citation form]*, (e.g. NH₄ ↔ NH₄-N).
 - Select a different measuring unit with *[Unit]*, (e.g. mg/l ↔ mmol/l).
 - Make further settings with *[Setup]* (see section 4.5.6).

4.5.4 Exceeding the upper or lower limits of the measuring range

Measured values outside the limits of the measuring range are displayed in red.

Measured value display if the measured value is outside the measuring range:

| Range | Display | Example: MR: 10 - 150 mg/l |
|---|---|---|
| LL < MV < UL | Measured value | 128 mg/l |
| 1 UL < MV < UL + 10% | Upper limit of measuring range exceeded by up to 10% and measured value | > 150 157 mg/l |
| | LL - 50% < MV < UL | Lower limit of measuring range undercut by up to 50% and measured value |
| 2 MV > UL + 10% | Upper limit of measuring range exceeded by more than 10% | > 150 mg/l |
| | MV < LL - 50% | Lower limit of measuring range undercut by more than 50% |
| 3 Invalid measured value e.g. MV < 0 | Lines | - - - - - mg/l |
| MR = Measuring range UL = Upper limit value of the measuring range LL = Lower limit value of the measuring range MV = Measured value | | |

4.5.5 Selecting a method manually

Selecting the method last used

```
<HOME>
Concentration
└─ [Last method]
```

The method last used is immediately selected.

Selecting a method from the *Method list*

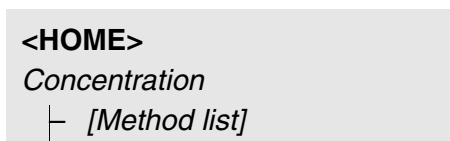

| | | | |
|------------------------------|-------|--------------------|--------------------|
| Select method (all) | | 16.01.15 9:52 | |
| Search: <input type="text"/> | | | |
| 1 | C3/25 | COD | 10 - 150 mg/l |
| 2 | C4/25 | COD | 25 - 1500 mg/l |
| 3 | A6/25 | NH ₄ -N | 0.20 - 8.00 mg/l |
| 4 | N2/25 | NO ₃ -N | 0.5 - 25.0 mg/l |
| 5 | N5/25 | NO ₂ -N | 0.010 - 0.700 mg/l |
| 6 | P6/25 | PO ₄ -P | 0.05 - 5.00 mg/l |
| 7 | P7/25 | PO ₄ -P | 0.5 - 25.0 mg/l |
| 160 | 09717 | Pb | 0.10 - 5.00 mg/l |
| 67 | 14834 | Cd | 0.025 - 1.000 mg/l |
| 39 | 14552 | Cr | 0.05 - 2.00 mg/l |
| Last used | | | |

The list of methods is displayed. The methods are ordered according to the method number. The arrows ▼ or ▲ on the right edge indicate that the list comprises more methods further up or down. The method last selected is highlighted.

Select the method:

- 1 Select the required method with <▲ ><▼ >. The active selection is displayed in reverse video.
- 2 Accept the selection with <START·ENTER>.

Narrowing down the method list

You can narrow down the method list and thus make the search easier:

- Using [*Last used*], you can restrict the method list to the ten methods last used.
- With the search function you can search certain character strings in the list. The search takes place as a full-text search of the entire list contents. Thus you can search for a method number, test name or certain citation form.

Search function

| | | | |
|----------------------------------|-------|---------------|----------------|
| Select method (last used) | | 16.01.15 9:52 | |
| <input type="text" value="CO_"/> | | | |
| 14 | 14540 | COD | 10 - 150 mg/l |
| 23 | 14541 | COD | 25 - 1500 mg/l |
| All methods | | | |

Search for a character string:

Enter the character string to be searched for in the search window with <A...9>.

The list appearing below shows all hits containing the character string. The hit list is updated with each character that is entered.



Note the case sensitivity when searching. It is not required or possible to enter inferior characters. They are treated as normal characters.

4.5.6 Settings for *Concentration* mode

Prior to measuring, check the settings for the selected method.

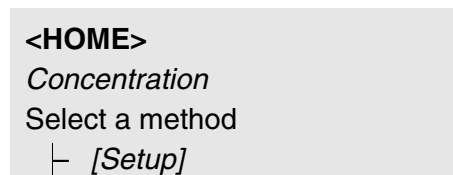

| Concentration | 16.01.15 9:52 |
|--------------------------|---------------|
| Barcodeerkennung ✓ | |
| Dilution ✓ | |
| Sample blank value | |
| User-defined blank value | |
| Turbidity correction | |
| Display absorbance | |
| AQA | |
| Edit method | |
| New method | |
| Measurement data memory | |

The menu shows an overview of all settings.

Active settings are marked by a tick.

Overview of the settings

| Menu item | Explanation |
|---------------------------------|--|
| <i>Bar code recognition</i> | <p>Activates/deactivates the automatic bar code recognition.</p> <p>If the automatic bar code recognition function results in an error (incorrect method), you can disable the function and select a method manually.</p> |
| <i>Dilution</i> | <p>In the measured value display, the dilution of a sample is indicated in the form [1 + x] (parts sample + parts distilled water).</p> <p>For more information, see section 4.5.7.</p> |
| <i>Sample blank value</i> | <p>In the measured value display, measurements with sample blank value are marked by [SB] (Sample blank).</p> <p>For more information, see section 4.5.8.</p> |
| <i>User-defined blank value</i> | <p>If available, a user-defined reagent blank value is used.</p> <p>In the measured value display, measurements with a user-defined reagent blank value are marked by [BV/Lot number].</p> <p>For more information, see section 4.5.9.</p> |

| Menu item | Explanation |
|--------------------------------|---|
| <i>Turbidity correction</i> | Activates/deactivates the automatic turbidity correction. In the measured value display, measurements with automatic turbidity correction are marked by [TURB]. For more information, see section 4.5.11. |
| <i>Display absorbance</i> | Activates/deactivates the display of the absorbance value in addition to the main measured value. |
| <i>AQA</i> | View and change the AQA settings without discarding the current measurement. |
| <i>Edit method</i> | Edit user-defined methods. |
| <i>New method</i> | Create user-defined methods. |
| <i>Measurement data memory</i> | View the measurement data memory. |

4.5.7 Measuring diluted samples

If the concentration of a sample exceeds the measuring range of a method, you can dilute the sample so that the concentration of the diluted sample is in the measuring range of the method. Thus a valid measurement is possible.

After entering the factor for the dilution the meter converts the concentration to that of the undiluted sample.



Optimum measurement results are achieved if the concentration of the diluted sample is in the middle of the measuring range of the method after diluting.

Setting the dilution

<HOME>
Concentration

| | |
|--|---------------|
| Concentration | 16.01.15 9:52 |
| Please select method for measuring or insert a barcoded cell or insert AutoSelector. | |
| Setup | Method list |
| Last method | New Method |

Inserting a cell with barcode starts a measurement.

If a cell without barcode is used:
 Select the method manually
 (see section 4.5.5).

| | |
|---|--------------------|
| Concentration | 16.01.15 9:52 |
| To start measurement, insert cell or press <START/ENTER> | |
| 3: A6/25 | NH ₄ -N |
| 16 mm | 0.20 - 8.00 mg/l |
| Setup | Method list |
| Citation form | Unit |

The photometer is ready to measure.

| | |
|-----------------------------------|--------------------|
| Concentration | 16.01.15 9:52 |
| Sample + distilled water 1 + _ | |
| 3: A6/25 | NH ₄ -N |
| 16 mm | 0.20 - 8.00 mg/l |
| Setup | Method list |
| Citation form | Unit |

- 1 Open the setting menu with [Setup].
- 2 Select and confirm *Dilution*.
- 3 Enter and confirm the dilution (<0...9>).

The entered dilution is taken into account with the next measurement.

The entered value for the dilution factor is valid for the selected method only.
 The dilution factor is erased if

- the photometer is switched off
- a different method is selected
- the factor 0 is entered in the *Dilution* menu.

If a dilution factor is active, it is indicated on the display during measurement in the form [1 + x].

4.5.8 Sample blank value

By measuring and using a sample blank value, measurement errors due to coloring and turbidity of the sample matrix can be eliminated to a large extent.

The sample blank value is a characteristic of the sample (coloration) to be currently determined. It is determined by measuring the blank sample.

The sample blank value is determined with the same procedure as the corresponding analysis but without the coloring reagent. The sample blank values required are explained in detail in the relevant analysis specification.

Validity

The sample blank value applies to the next measurement only. It has to be redetermined prior o each measurement.

Single and multiple determination

The sample blank value can be determined by single or multiple determination. With multiple determination, the sample blank value is calculated as the median from the individual measured values.

Measuring the sample blank value

<HOME>
Concentration

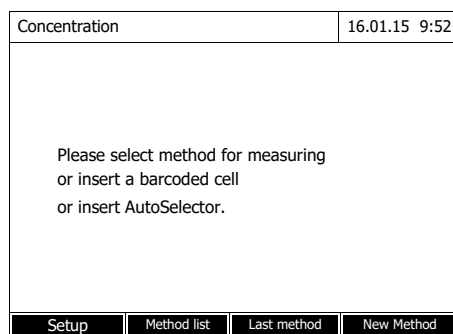

Inserting a cell with barcode starts a measurement.

If a cell without barcode is used: Select the method manually (see section 4.5.5).

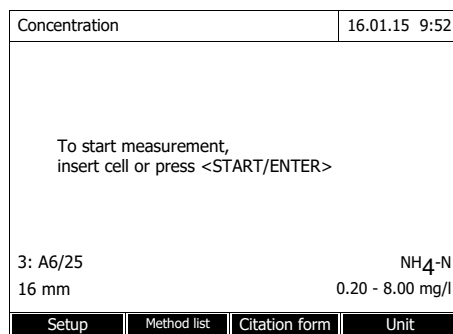

The photometer is ready to measure.

- 1 Open the setting menu with [Setup].
- 2 Select and confirm *Sample blank value*.

| | |
|---|--|
| Sample blank value | 16.01.15 9:52 |
| To start measurement, insert cell or press <START/ENTER> | |
| 3: A6/25 16 mm | NH ₄ -N 0.20 - 8.00 mg/l |
| | |

3 Insert the cell with a suitable blank sample.

The first single measurement for the sample blank value takes place.

The following data is displayed as the result:

- The measured absorbance from the (last) single measurement.
- The median from all single measurements carried out up to now.

| | |
|---|--|
| Sample blank value | 16.01.15 9:52 |
| Last measured absorbance 0.115 Median 0.115 (1 Measurement(s)) | |
| 3: A6/25 16 mm | NH ₄ -N 0.20 - 8.00 mg/l |
| Next meas. | Discard |
| | Apply |

4 If necessary, carry out further single measurements for the formation of the median with *[Next meas.]* or discard the last single measurement with *[Discard]*.

5 To accept the median value, press *[Apply]*.

| | |
|---|--|
| Concentration | 16.01.15 9:52 |
| [SB] | |
| To start measurement, insert cell or press <START/ENTER> | |
| 3: A6/25 16 mm | NH ₄ -N 0.20 - 8.00 mg/l |
| Setup | Method list |
| Citation form | Unit |

The photometer is ready to measure.

The use of the sample blank value is indicated by [SB] in the top right corner of the display.

4.5.9 Reagent blank value

The evaluation of the photometric measurement always refers to the comparison value of a test sample without the substance to be determined (reagent blank value). Thus the influence of the basic absorbance of the reagents on photometric measurement, e.g. the inherent coloring, is taken into account.

In practice, the reagent blank value is measured with the same amount of de-ionized water instead of sample.

Factory and user-defined reagent blank values

With photometric concentration determination, the reagent blank value is a constant. The method data for all measurements with WTW test sets (*Concentration mode*) include an exactly determined reagent blank value. This value is overwritten if you measure the reagent blank value yourself (setting, *User-defined blank value*, see section 4.5.6).



You can increase accuracy if you determine the reagent blank value with a test of a new lot and use the reagent blank value for all further measurements with this lot. This is especially recommended for measurements in the vicinity of the lower limit of the measuring range. To be able to attribute the reagent blank value in the measured value documentation later, you can enter the lot number of the reagent package (*Lot number*) during the blank value determination.

Validity

The factory blank values always remain stored in the meter and can be activated at any time. The reagent blank values you measured yourself also remain stored in the meter until they are overwritten by a new blank value measurement.

Single and multiple determination

The reagent blank value can be determined with single or multiple determination. With multiple determination, the reagent blank value is calculated as the median from the individual measured values.

User-defined methods

For user-defined methods, you can activate the reagent blank value function as follows only:

| Entry type | Function type | Reagent blank value possible? |
|---|----------------------------------|-------------------------------|
| Entry of a function (with and without entering the ordinate intercept) | Linear | Yes |
| | Nonlinear | No |
| Entry of value pairs or measurement and storage of standard solutions (with entering/measuring and storing E0) | Linear | Yes |
| | Parabola (second-order function) | Yes |
| | Polygon line | No |
| Entry of value pairs or measurement and storage of standard solutions (without entering/measuring and storing E0) | Linear | Yes |
| | Parabola (second-order function) | No |
| | Polygon line | No |
| | Polygon line through zero | No |



If no value for E0 is stored during the entry of value pairs or the measurement and storing of standard solutions for a nonlinear function (parabola or polygon line), the message, *No blank value correction is intended for this method.* appears when the *User-defined blank value* function is activated. The blank value (E0) can be entered later by editing the method.

Measuring the reagent blank value

<HOME>
Concentration

| | |
|--|--|
| Concentration | 16.01.15 9:52 |
| Please select method for measuring or insert a barcoded cell or insert AutoSelector. | |
| Setup | Method list Last method New Method |

Inserting a cell with barcode starts a measurement.

If a cell without barcode is used: Select the method manually (see section 4.5.5).

| | |
|---|--|
| Concentration | 16.01.15 9:52 |
| To start measurement, insert cell or press <START/ENTER> | |
| 3: A6/25 16 mm | NH ₄ -N 0.20 - 8.00 mg/l |
| Setup | Method list Citation form Unit |

The photometer is ready to measure.

| | | | | | |
|---|--|--------|-----------------|---------------------|----------------------|
| Concentration | 16.01.15 9:52 | | | | |
| <table border="1"> <tr><td>Adjust</td></tr> <tr><td>Zero adjustment</td></tr> <tr><td>Reagent blank value</td></tr> <tr><td>Calibrate the method</td></tr> </table> | | Adjust | Zero adjustment | Reagent blank value | Calibrate the method |
| Adjust | | | | | |
| Zero adjustment | | | | | |
| Reagent blank value | | | | | |
| Calibrate the method | | | | | |
| 3: A6/25 16 mm | NH ₄ -N 0.20 - 8.00 mg/l | | | | |
| Setup | Method list Citation form Unit | | | | |

1 Using <ZERO-BLANK>, open the *Adjust* selection list.

or

Open the setting menu with *[Setup]*.

2 Select and confirm *Reagent blank*.

The window for the measurement of the reagent blank value pops up.

The data of the last measurement appears in the measured value display.

| | |
|---|--|
| Reagent blank value | 16.01.15 9:52 |
| To start measurement, insert cell or press <START/ENTER> | |
| 3: A6/25 16 mm | NH ₄ -N 0.20 - 8.00 mg/l |

3 Insert the cell with the blank sample.

The first single measurement for the reagent blank value takes place.

The following data is displayed as the result:

- The measured absorbance from the (last) single measurement.
- The median from all single measurements carried out up to now.

| | |
|---|--|
| Reagent blank value | 16.01.15 9:52 |
| Last measured absorbance 0.600 Median 0.600 (1 Measurement(s)) | |
| 3: A6/25 16 mm | NH ₄ -N 0.20 - 8.00 mg/l |
| Next meas. | Discard |
| Apply | |

4 If necessary, carry out further single measurements for the formation of the median with [*Next meas.*] or discard the last single measurement with [*Discard*].

5 To accept the median value, press [*Apply*].

The *Lot number* entry field pops up.

6 Enter and confirm the *Lot number* (<**A...9**>). The blank value measurement is completed.

| | |
|---|--|
| Reagent blank value | 16.01.15 9:52 |
| [BV/Lot number] | |
| To start measurement, insert cell or press <START/ENTER> | |
| 3: A6/25 16 mm | NH ₄ -N 0.20 - 8.00 mg/l |
| Setup | Method list |
| Citation form | Unit |

The photometer is ready to measure.

The use of the reagent blank value is indicated by [BV/Lot number] in the top right corner of the display.

4.5.10 User calibration (standard adjustment)

With some methods for concentration measurement, there is the possibility to optimize with a user calibration the original calibration stored with the

method.

This makes sense, for example, if the original calibration of the method has changed due to the lot.

When creating a user-defined method you can also allow a user calibration (see section 4.5.12).

A user calibration is only valid if it deviates from the original calibration by at least 30%.

The absorbance for a user calibration can be measured as a single measurement or multiple measurement. With multiple measurement, the absorbance is calculated as the median from the individual measured values.

If a method is called up for which a user calibration is possible, a query appears asking whether the user calibration should be utilized.

If a method is called up for which a user calibration is required, the user calibration has to be carried out before the first measurement.

The implementation of the user calibration is documented together with the measured value and indicated in the measured value display by [Cal].

Validity

A user calibration is always stored for the method just called up. A user calibration is only erased if

- a new user calibration is carried out
- the original calibration is selected for measurement
- the user calibration is erased manually
- the photometer is reset to the default condition.

Performing a user calibration

<HOME>
Concentration

| Concentration | 16.01.15 9:52 |
|--|---------------|
| Please select method for measuring or insert a barcoded cell or insert AutoSelector. | |
| Setup | Method list |
| Last method | New Method |

Select the method manually (see section 4.5.5).

If data for zero adjustment, reagent blank value or a user calibration are already existing, the photometer informs you of this. You can accept or discard the existing values.

If no zero adjustment is available, the photometer will prompt you to carry out a zero adjustment.

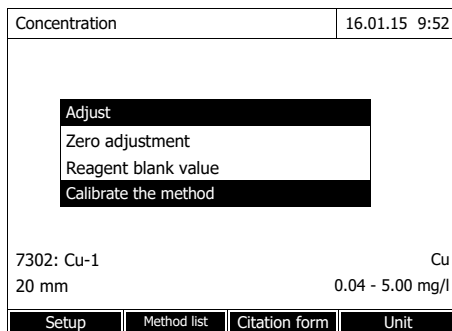

1 Using **<ZERO-BLANK>**, open the *Adjust* selection list.

or

Open the setting menu with *[Setup]*.

2 Select and confirm *Calibrate the method*.

If data for a user calibration are already existing, the list for all standard solutions includes the calibration data of the last user calibration.

If no data of a user calibration are available, the list to measure the *Absorbance* for all calibration standards required pops up.

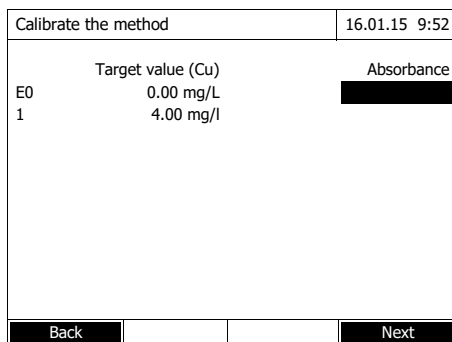

3 In the *Target value* column, enter the nominal values of the individual standard solutions.

For E0 (reagent blank value) the nominal value is fixed and cannot be changed. The corresponding absorbance has to be measured.

4 Select an absorbance value and confirm with **<START-ENTER>**.

The measurement window pops up.

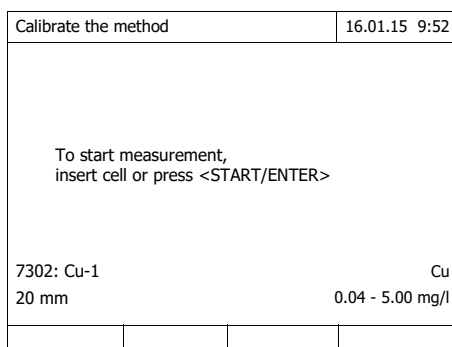

5 Insert the cell with the corresponding standard or reagent blank value (for E0).

The first single measurement for the calibration is carried out.

The following data is displayed as the result:

- The measured absorbance from the (last) single measurement.
- The median from all single measurements carried out up to now.

| | | |
|---|---------|------------------|
| Calibrate the method | | 16.01.15 9:52 |
| Last measured absorbance 0.600 Median 0.600 (1 Measurement(s)) | | |
| 7302: Cu-1 | | Cu |
| 20 mm | | 0.04 - 5.00 mg/l |
| Next meas. | Discard | Apply |

- 6 If necessary, carry out further single measurements for the formation of the median with *[Next meas.]* or discard the last single measurement with *[Discard]*.
- 7 To accept the median value, press *[Apply]*.

The list of the standards required for this method pops up. The measured absorbance is entered for the standard or reagent blank value (E0).

| | | |
|----------------------|-------------------|---------------|
| Calibrate the method | | 16.01.15 9:52 |
| | Target value (Cu) | Absorbance |
| E0 | 0.00 mg/L E | 0.000 |
| 1 | 4.00 mg/l 1 | 0.600 |
| Back | | Next |

- 8 Select all fields consecutively in the column *Absorbance* and start the corresponding measuring procedure with **<START·ENTER>**.

When all values have been measured (including the reagent blank value E0):

- 9 Accept the values with *Next*.

The result of the calibration pops up.

| | | |
|--|---------------|---------------|
| Calibrate the method | | 16.01.15 9:52 |
| The calibration has been successfully completed. | | |
| Protocol ID: | 2 | |
| Date: | 16.01.2012 | |
| User: | Admin | |
| Curve type: | Straight line | |
| Correction: | 105% | |
| 7302: Cu-1 | | Cu |
| Cancel | Calibration | Apply |

If necessary, display the list with the value pairs nominal value and absorbance with *Calibration data*.

If necessary, display the calibration line with *Graphic* in the window with the value pairs.

- 10 Accept the calibration with *Apply*.

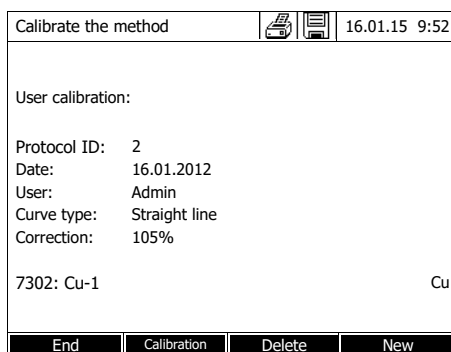

If necessary, display the list with the value pairs nominal value and absorbance with *Calibration data*.

If necessary, display the calibration line with *Graphic* in the window with the value pairs.

If necessary, erase the user calibration with *Delete*.

If necessary, carry out a new user calibration with *New measurement*.

11 Use *End* to finish calibration.

The input field *Lot number* pops up. Here you can input the *Lot number* of the reagent blank value (E0).

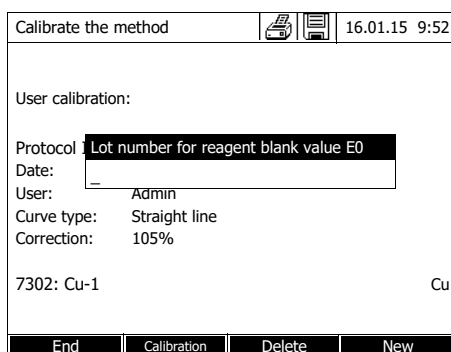

12 Enter the *Lot number* of the reagent blank value (<A...9>) and confirm.

The user calibration is completed.

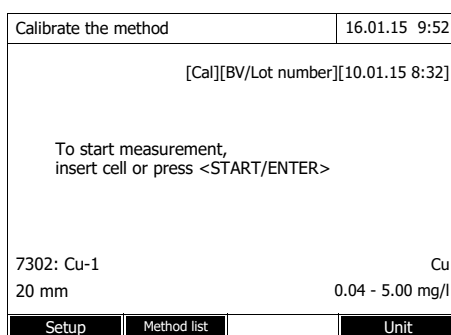

The photometer is ready to measure.

If the user calibration is utilized, [Ca] appears on the display.

Note: calibration is not successful if a new value deviates by more than 30 % from the value of the old calibration.

Viewing the data of the user calibration

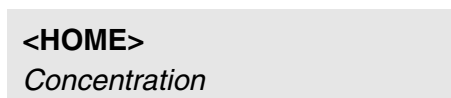

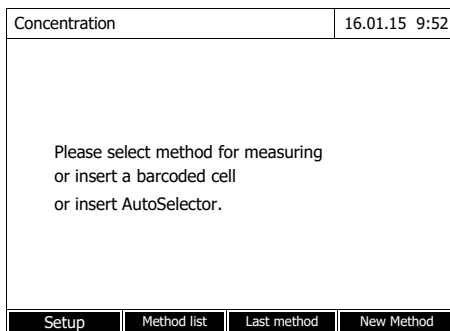

Select the method manually (see section 4.5.5).

If data for zero adjustment, reagent blank value or a user calibration are already existing, the photometer informs you of this. You can accept or discard the existing values.

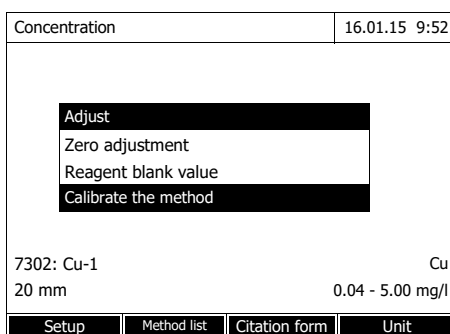

1 Using <ZERO-BLANK>, open the *Adjust* selection list.

or

Open the setting menu with [*Setup*].

2 Select and confirm *Calibrate the method*.

The *Calibrate the method* window opens.

The data of the last measurement appears in the window.

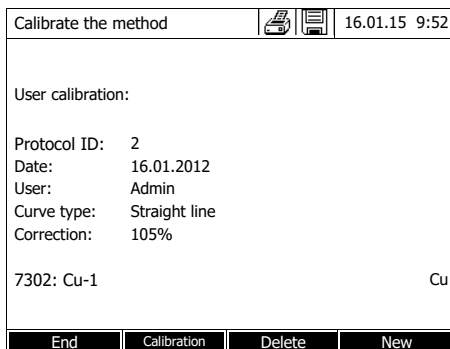

Measuring with user calibration

<HOME>
Concentration

| | |
|---|------------------------|
| Concentration | 16.01.15 9:52 |
| [Cal][BV/2c][ZERO 10.01.2012 11:08] | |
| <div style="border: 1px solid black; padding: 5px;"> <p>User calibration</p> <p>A calibration dated xxx is available for this method. Should it be used?</p> <p>Yes</p> <p>No</p> </div> | |
| 7302: Cu-1 12 mm | Cu 0.04 - 5.00 mg/l |
| Setup | Method list |
| Citation form | Unit |

Select the method manually (see section 4.5.5).

If data for zero adjustment, reagent blank value or a user calibration are already existing, the photometer informs you of this. You can accept or discard the existing values.

If the existing user calibration should not be utilized, a query with further options pops up:

- *Use default calibration*
The existing user calibration is erased. The following measurements are done with the original calibration that was stored with the method.
- *Carry out user calibration*
The existing user calibration is erased. The process for a new user calibration is started.
- *Cancel*
The existing user calibration is retained. The previous query is displayed.

| | |
|---|------------------------|
| Concentration | 16.01.15 9:52 |
| [Cal][BV/2c][ZERO 10.01.2012 11:08] | |
| <p>To start measurement, insert cell or press <START/ENTER></p> | |
| 7302: Cu-1 12 mm | Cu 0.04 - 5.00 mg/l |
| Setup | Method list |
| Citation form | Unit |

The photometer is ready to measure when all the required data have been confirmed or remeasured.

4.5.11 Automatic Turbidity correction

The *Turbidity correction* function activates the automatic recognition and compensation of the light absorption caused by turbid substances.

After activating the function remains permanently switched on. Measured values that were measured with *Turbidity correction* are labeled with [TURB] (turbidity correction) on the display and in the documentation (printout and memory).

The *Turbidity correction* function is not active in the delivery condition.



The setting for automatic turbidity correction is used with all methods where the automatic turbidity correction makes sense. The photometer automatically decides whether or not to use the function.

Switching on the turbidity correction

The automatic turbidity correction is activated and deactivated in the setting menu of the concentration measurement (see section 4.5.6 SETTINGS FOR Concentration MODE).

4.5.12 Programming / modifying user-defined methods

Overview

For *Concentration* mode, you can develop and store yourself user-defined methods under the method numbers 1001 to 1100. The photometer software supports you when creating the methods.

Calibration data and calibration function

In photometry, the calibration function describes the dependency between the measured parameter (e.g. concentration) and the photometric measurement result (e.g. absorbance) of a sample. The knowledge of this dependency is a prerequisite for the development of a photometric method. The calibration function is usually determined by means of a series of measurements with standard solutions of known concentrations (nominal value), e.g. a 10-point calibration.



In measuring operation, the reverse calibration function is used to output the measured absorbance as a concentration value.

Line types

The dependency between the nominal value and absorbance is often linear

in a wide range as shown in the following example:

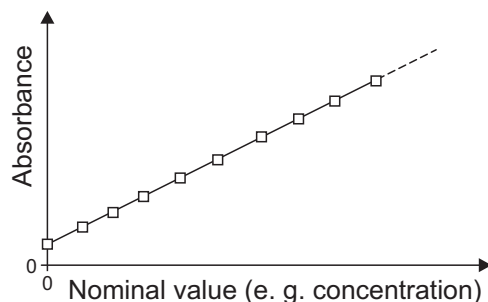

Fig. 4-1 Example of a linear calibration function after a 10-point calibration

In the case of a linear dependency, the calibration function is determined by means of linear regression. The slope and axis intercept (E0) are the characteristics of the calibration line.

In the case of a nonlinear dependency, the points of the measuring ranges can be connected to each other as a polygon line or approximated as a parabola:

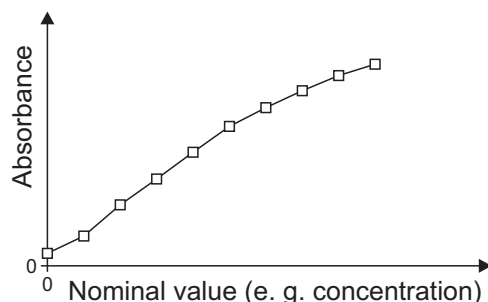

Fig. 4-2 Example of a polygon line calibration function after a 10-point calibration

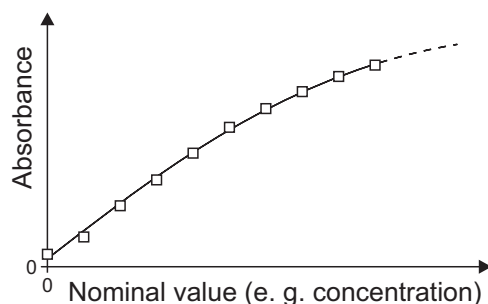

Fig. 4-3 Example of a parabola calibration function after a 10-point calibration

Determining the calibration function

You have the following options to create a method:

- **Measure and store:**

Carry out a series of measurements with the following sample solutions while at the same the photometer takes over the values:

- Blank sample to determine the reagent blank value (with deionized water instead of sample, see section 4.5.9)
- at least one, up to ten standard solutions in different concentrations.

The photometer stores nominal value/absorbance value pairs of the individual measurements and determines the resultant characteristics of the calibration. When doing so, you can select the following line types: *Polygon line*, *Straight line* or *Parabola*.

● **Enter as value pairs:**

Entry of the value pairs, Nominal value (concentration) / Measured absorbance of an already available test series with the following sample solutions:

- Blank sample to determine the reagent blank value (with deionized water instead of sample, see section 4.5.9)
- at least one, up to ten standard solutions in different concentrations.

Based on the entered value pairs, the photometer determined the characteristics for the calibration. When doing so, you can select the following line types: *Polygon line*, *Straight line* or *Parabola*.

● **Enter a function:**

Entry of a function to calculate the concentration from the absorbance (reverse calibration function). You can enter on the photometer the coefficients of a polynomial equation of the following type:

$$c = a_0 + a_1 \cdot A + a_2 \cdot A^2 + a_3 \cdot A^3 + a_4 \cdot A^4 + a_5 \cdot A^5$$

with:

| | |
|----------|--|
| c | Measurement result, e.g. concentration |
| a0 to a5 | Coefficients (input range 0.000 to 1000.000) |
| A | Absorbance |



Entering the formula is especially simple if you measure with a commercial test set for which the manufacturer has given the value for the coefficients a1. It is often called the "Factor" and corresponds to the reciprocal value of the slope of the straight line of the calibration function.

If a linear function (straight line) should be entered, it is necessary to enter the coefficients a0 and a1 to receive correct measured values.

If the exact value for a_0 is not known at the time the formula is entered, it is sufficient to enter the coefficient a_1 . In this case, the *User-defined blank value* function (in the *Concentration / Setup* menu) has to be activated to measure with this method.

Prior to measuring with this method, a blank value measurement has to be carried out. This procedure determines the value for a_0 , which then replaces the value from the programming of the method.

If the *User-defined blank value* function is not activated, the photometer uses the value zero for the coefficient a_0 .

**More information on
the entry of the
formula
(determination of
coefficients)**

Linear function If the value for a_1 (slope of the reverse calibration function) is unknown, you can very simply program the method in the photometer by measuring/storing or entering the value pairs (see above).

For entry as a formula, you can determine the coefficients of the reverse calibration function by linear regression. When doing so, the concentration has to be on the Y axis and the absorbance on the X axis.

In the case of a linear function, the coefficients of the reverse calibration function can also be determined from the reagent blank value determined and the slope (m) of the calibration function (Y axis = absorbance, X axis = concentration). Proceed as described below.

Explanation of the coefficients of the formula:

- $a_0 = -E_0 \cdot a_1$
[E_0 = reagent blank value
(absorbance at concentration 0)]
- $a_1 = 1/m$
Reverse value of the slope of the calibration function
(often referred to as "Factor")
 m = slope of the calibration function
- a_2, a_3, a_4, a_5 = further coefficients
(when entering a linear function: zero)

Nonlinear function The coefficients of the reverse calibration function are determined by multiple regression. When doing so, the concentration has to be on the Y axis and the absorbance on the X axis.

| Further method data | Input field | Possible entries |
|---------------------|--|--|
| | <i>Number</i> * | 1001 ... 1100 |
| | <i>Designation</i> | Any name (max. 18 characters) |
| | <i>Version</i> | Any version designation (max. 18 characters) |
| | <i>Wavelength</i> * | Freely selectable (in nm) |
| | <i>Cell</i> * | 16 (round), 10, 20 or 50 mm |
| | <i>Citation form</i> | e.g. PO4-P (max. 18 characters) |
| | <i>Unit</i> ** | e.g. mg/l (max. 18 characters) |
| | <i>Resolution</i> * | 0.001, 0.01, 0.1 or 1 |
| | Lower and upper limit of the measuring range * | Any value between zero and the highest concentration of the used standard solutions |
| | Timer 0 to 3 | Up to four analysis timers freely adjustable |
| | <i>AQA2 target value</i> | Any value within the measuring range |
| | <i>AQA2 tolerance</i> | Any |
| | <i>Required measurements</i> | 1 or greater Number of measurements after which a measured value is documented. With more than one measurement, the documented value is the median from all measurements. |
| | <i>Reagent blank value required</i> | Yes/No |
| | <i>User calibration possible</i> | Yes/No |
| | <i>User calibration required</i> | Yes/No |

* necessary inputs

** default: mg/l



If a nonlinear calibration line is programmed for a method, it may be the case that the default setting of the following menu items cannot be changed:

- *Reagent blank value required*
- *User calibration possible*
- *User calibration required*

How to program user-defined methods

```

<HOME>
Concentration
├─ [Setup]
└─ New method
  
```

| Edit method | | 16.01.15 9:52 |
|-------------------|-------|----------------------------|
| Number | _____ | 1001 |
| Designation | _____ | Nitrite |
| Version | _____ | 01 |
| Wavelength | _____ | 525 |
| Cell | _____ | 10 mm |
| Citation form | _____ | NO2-N |
| Unit | _____ | mg/l |
| Resolution | _____ | 0.001 |
| Calibration curve | _____ | Measure standard solutions |

Method list Delete Next

1 Enter the general method data here. The next available method number is already entered as the number.

You have the following options when filling out the input fields:

- Fill out all empty input fields one after the other
- Using *[Method list]*, select an already existing method as a model, give it a new method number and adjust the entries
- Using *[Method list]*, select an existing method in order to change it (without changing the number).
- You can delete the method completely with *[Delete]*.

2 Select the menu item, *Calibration curve*. Select the method for the determination of the calibration line. The following variants can be selected:

- *Measure standard solutions*
- *Enter value pairs*
- *Enter formula*

3 Using *[Next]*, accept all entries on the page and switch to the next page.



During the following proceeding, you can return to the previous page at any time with *[Back]*, e. g. if you want to correct entries, add further value pairs or eliminate outliers.

**Variant 1:
Measure standard
solutions**

| | |
|-----------------------|---------------|
| Edit method | 16.01.15 9:52 |
| Standard ID | [REDACTED] |
| Standard manufacturer | |
| Back | Next |

- 1 Select and confirm *Measure standard solutions*.
- 2 Enter and confirm details of the standard solutions (optional).
- 3 Using *[Next]*, accept all entries on the page and switch to the next page.

The table for the measurement of standard solutions pops up.

| | | | |
|-------------|--|--------|------|
| Edit method | 16.01.15 9:52 | | |
| | Target value Absorbance | | |
| E0 | 0.000 [REDACTED] | | |
| 1 | | | |
| Back | Add | Delete | Next |

In the first two lines of the table, the two value pairs (measuring points) that are at least required for a calibration are already prepared (reagent blank value E0 and any further nominal value).

| | | | |
|-------------|--|--------|------|
| Edit method | 16.01.15 9:52 | | |
| | Target value Absorbance | | |
| E0 | 0.000 | | |
| 1 | 0.300 | | |
| 2 | 0.600 | | |
| 3 | 1.000 | | |
| Back | Add | Delete | Next |

- 4 Create further values pairs with *[Add]* as necessary.
- 5 In the *Target value* column, enter the nominal values of the individual standard solutions.

Measuring the standard solutions:

| | | | |
|-------------|--|--------|------|
| Edit method | 16.01.15 9:52 | | |
| | Target value Absorbance | | |
| E0 | 0.000 [REDACTED] | | |
| 1 | 0.300 | | |
| 2 | 0.600 | | |
| 3 | 1.000 | | |
| Back | Add | Delete | Next |

- 6 Using the arrow keys <▲ ><▼ > and <<◀ >>▶ >, navigate to the relevant input field in the *Absorbance* column and press <START·ENTER>.

| | | | |
|---|--|---------------|--|
| Absorbance E0 | | 16.01.15 9:52 | |
| To start measurement, insert cell or press <START/ENTER> | | | |
| 525 nm | | 16 mm | |
| | | | |

The measurement display appears.

- 7 Insert the cell with the respective standard.

The absorbance is measured. The result of the first single measurement is displayed.

| | | | |
|---|---------|---------------|-------|
| Absorbance E0 | | 16.01.15 9:52 | |
| Last measured absorbance 0.009 Median 0.009 (1 Measurement(s)) | | | |
| 525 nm | | 16 mm | |
| Next meas. | Discard | | Apply |

- 8 If necessary, carry out further single measurements for the formation of the median with *[Next meas.]* or discard the last single measurement with *[Discard]*.
- 9 To accept the median value, press *[Apply]*.



If the zero standard concentration (reagent blank value E0) is not measured and stored, the photometer calculates the calibration line without this value. If the function *User-defined blank value* (in the *Concentration / Setup* menu) is activated for measuring with this method, the value for a0 is determined and replaces the calculated axis intercept from the programming of the method (a0 see page 60).

| | | | |
|-------------|--------------|---------------|------|
| Edit method | | 16.01.15 9:52 | |
| | Target value | Absorbance | |
| E0 | 0.000 | 0.009 | |
| 1 | 0.300 | 0.664 | |
| 2 | 0.600 | 1.292 | |
| 3 | 1.000 | 2.178 | |
| Back | Add | Delete | Next |

- 10 Repeat the steps 6 to 9 until all input fields in the *Absorbance* column are filled out.
- 11 Using *[Next]*, accept all entries on the page and switch to the next page.

The value pairs are displayed in a diagram (standard: Polygon line).

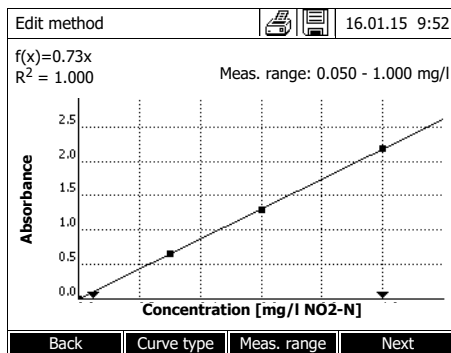

The related formula $f(x)$ and correlation coefficient R^2 are displayed above the diagram.

12 If required, select a different line type for the line adjustment with *[Curve type]*.

- Polygon line
- Straight line
- Parabola

13 If required, enter different measured value limits with *[Meas. range]*.

- Lower limit
- Upper limit

14 Using *[Next]*, complete the editing of the calibration line and proceed to the next page.

The timers and AQA2 data linked to the method are displayed.

| Edit method | | 16.01.15 9:52 |
|------------------------------|--|---------------|
| Timer 0 | | 00:00:00 |
| Timer 1 | | 00:00:00 |
| Timer 2 | | 00:00:00 |
| Timer 3 | | 00:00:00 |
| AQA2 target value | | 1.00 mg/l |
| AQA2 tolerance | | 0.10 mg/l |
| Required measurements | | 1 |
| Reagent blank value required | | No |
| User calibration possible | | No |
| User calibration required | | No |

Buttons: Back, Complete

15 If necessary, enter intervals for up to 4 timers.

16 If necessary, enter the *AQA2 target value* and *AQA2 tolerance*.

17 If necessary, set the number from how many single measurements the documented measured value will be calculated.

18 If necessary, specify whether a reagent blank value is required.

19 If necessary, set whether a user calibration is possible and/or required.

20 Complete the programming of the method with *[Complete]*.

The method is programmed and selected for measuring.

**Variant 2:
Enter value
pairs**

Unlike variant 1, the fields of the *Absorbance* column are filled out manually here. Accordingly, the steps 6 to 10 are not applicable here. Apart from that, the proceeding is identical to variant 1.

Variante 3: Enter formula

| | |
|---|---------------|
| Edit method | 16.01.15 9:52 |
| c = a0 + a1·A + a2·A ² + a3·A ³ + a4·A ⁴ + a5·A ⁵ | |
| a0 | 0.605 |
| a1 | 2 |
| a2 | |
| a3 | |
| a4 | |
| a5 | |
| Lower limit of measuring range | 1.000 mg/l |
| Upper limit of measuring range | 3.000 mg/l |
| Method list | Delete |
| | Next |

- 1 Select and confirm *Enter formula*.
Input fields for the coefficients (a0 ... a5) of the formula are displayed.
- 2 Enter and confirm the factors.
If no value is entered for a coefficient the photometer automatically uses the value 0.



Entering the formula is especially simple if you measure with a commercial test set for which the manufacturer has given the value for the coefficients a1. It is often called the "Factor" and corresponds to the reciprocal value of the slope of the straight line of the calibration function.

If a linear function (straight line) should be entered, it is necessary to enter the coefficients a0 and a1 to receive correct measured values. If the exact value for a0 is not known at the time the formula is entered, it is sufficient to enter the coefficient a1. In this case, the *User-defined blank value* function (in the *Concentration / Setup* menu) has to be activated to measure with this method. Prior to measuring with this method, a blank value measurement has to be carried out. During this procedure the value for a0 is determined and replaces the previous value.

- 3 Enter and confirm the measuring range limits.
- 4 Complete the entering of the formula with *[Next]*.

The timers and AQA2 data linked to the method are displayed.

| Edit method | 16.01.15 9:52 |
|------------------------------|---------------|
| Timer 0 | 00:00:00 |
| Timer 1 | 00:00:00 |
| Timer 2 | 00:00:00 |
| Timer 3 | 00:00:00 |
| AQA2 target value | 2.000 mg/l |
| AQA2 tolerance | 0.200 mg/l |
| Required measurements | 1 |
| Reagent blank value required | No |
| User calibration possible | No |
| User calibration required | No |
| Back | Complete |

- 5 If necessary, enter intervals for up to 4 timers.
- 6 If necessary, enter the *AQA2 target value* and *AQA2 tolerance*.
- 7 If necessary, set the number from how many single measurements the documented measured value will be created.
- 8 If necessary, specify whether a reagent blank value is required.
- 9 If necessary, set whether a user calibration is possible and/or required.
- 10 Complete the programming of the method with [*Complete*].
The method is programmed and selected for measuring.

4.5.13 The IQ-LabLink procedure

The IQ-LabLink procedure enables the data exchange between the sensors of the IQ SENSOR NET online measuring system and a photometer (such as the photoLab® 6000 or 7000 series) with the aid of a commercial USB flash drive.

During the matrix adjustment of the sensor, the measurement data of the IQ SENSOR NET sensor are adjusted to the photometrically determined reference data.

With the aid of the IQ-LabLink procedure, the reference data can be directly transferred to the IQ SENSOR NET sensors with a USB flash drive.

System requirement for the IQ-LabLink procedure

- IQ SENSOR NET:
 - Terminal/controller with USB-A interface and software for the IQ-LabLink procedure (e.g. MIQ/TC 2020 XT)
 - Online sensor with software for the IQ-LabLink procedure (e.g. VARiON®*Plus* 700 IQ)
- Photometer:
 - Photometer with software for the IQ-LabLink procedure (e.g. photoLab® 7xxx)

Course of the IQ-LabLink procedure

Step 1 on the IQ SENSOR NET terminal:

Automatic creation of a job file on the USB memory device with current sensor values, parameters, designation of the measuring location and automatic allocation of a job reference number for clear identification.

Step 2 on the photometer:

Automatic recognition of the job files, menu-guided measurement of all required parameters, storage of the determined data in the job file.

Step 3 on the IQ SENSOR NET terminal:

Automatic recognition of the job files, complete reading of all data required for the matrix adjustment on keypressing.



The detailed description of the cross instrument operating steps for the matrix adjustment with the IQ-LabLink procedure on the IQ SENSOR NET and the photometer is given in an additional operating manual (IQ-LabLink). This operating manual can be downloaded from the Internet under www.wtw.com.

4.6 Measuring the Absorbance / % Transmission

4.6.1 General information

The absorbance or transmission respectively is measured without the use of any methods or profiles. All settings are configured during measurement.

Measuring against the Reference absorbance

The absorbance or transmission can alternatively be measured against the absorbance of the zero adjustment or against a *Reference absorbance* determined by yourself (see section 4.6.3 MEASURING AGAINST THE REFERENCE ABSORBANCE).

4.6.2 Measuring the absorbance or transmission

<HOME>
Absorbance / % Transmission

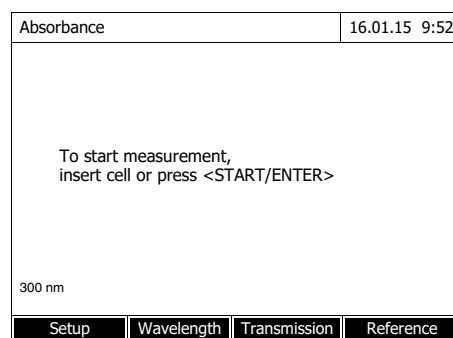

The settings of the last measurement are active.

- 1 Using *[Wavelength]*, change the wavelength as necessary.
- 2 Using *[Absorbance]* <→> *[Transmission]*, you can switch over between absorbance and transmission measurement.
- 3 If necessary, use or measure a reference measurement with *[Reference]* (see section 4.6.3).

- 4 Insert the cell (rectangular or round) (see section 4.2.5 INSERTING A CELL).

The photometer starts measuring automatically.

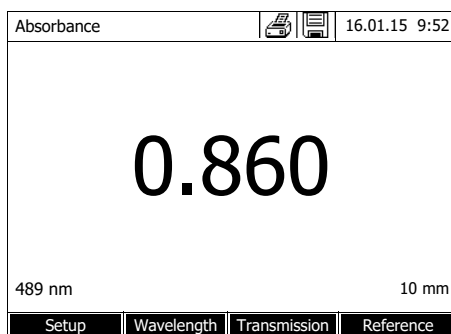

- 5 Using [Absorbance] <-> [Transmission], switch over the display from Absorbance to Transmission or vice versa.

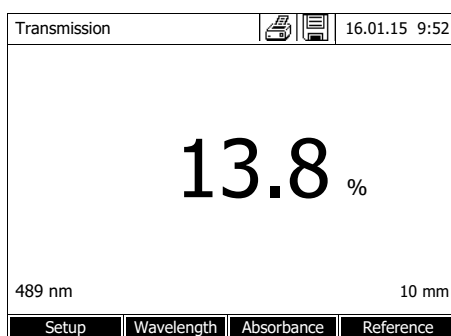

4.6.3 Measuring against the Reference absorbance

Each time the photometer is switched on, the absorbance or transmission is measured against the absorbance of the zero adjustment as a basis. You can, however, also determine a *Reference absorbance* and use it as the basis.

The *Reference absorbance* refers to the adjusted wavelength. The measured value remains stored until

- the photometer is switched off
- the cell type is changed
- the wavelength is changed
- a new reference value is measured
- it is deleted manually ([Reference] / Delete).
- the *Absorbance / % Transmission* measuring mode is exited

Single and multiple determination

The Reference absorbance can be determined with single or multiple determination. With multiple determination, the mean value is calculated as the median from the individual measured values.

**Reference absorbance
Measuring the**

<HOME>
Absorbance / % Transmission

| | |
|---|-----------------------------------|
| Absorbance | 16.01.15 9:52 |
| To start measurement, insert cell or press <START/ENTER> | |
| 489 nm | 10 mm |
| Setup | Wavelength Transmission Reference |

| | |
|---|---------------|
| Reference absorbance | 16.01.15 9:52 |
| To start measurement, insert cell or press <START/ENTER> | |
| 489 nm | 10 mm |
| | |

| | |
|---|---------------|
| Reference absorbance | 16.01.15 9:52 |
| Last measured absorbance 0.232 Median 0.232 (1 Measurement(s)) | |
| 489 nm | 10 mm |
| Next meas. | Discard Apply |

The settings of the last measurement are active.

- 1 Start the reference measurement with [*Reference*].

If a value for the reference absorbance is already stored, it can be deleted or overwritten by a new reference measurement.

After the reference absorbance value has been deleted, the photometer measures against the absorbance of the zero adjustment.

- 2 Insert the cell with the reference sample.

The first single measurement for the Reference absorbance is carried out.

The following data is displayed as the result:

- The measured absorbance from the (last) single measurement.
- The median from all single measurements carried out up to now.

- 3 If necessary, carry out further single measurements for the formation of the median with [*Next meas.*] or discard the last single measurement with [*Discard*].

- 4 To accept the median value, press [*Apply*].

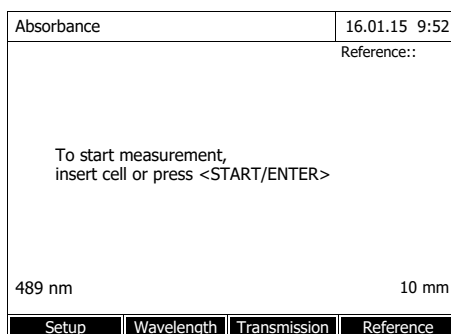

The photometer is ready to measure.

The reference absorbance is displayed in the top right corner during absorbance or transmission measurement.

4.7 Special / Multi wavelengths methods

4.7.1 Basic information on Special / Multi wavelengths measurements

In the Special / Multi wavelengths mode of the photoLab® 7600 UV-VIS, you can carry out measurements with special methods and functions.

You can use the following functions for these methods:

- Measurements at different wavelengths
- Multiple measurements at one wavelength (e.g. before and after adding a reagent)
- Use of procedure variables.
Procedure variables provide a value that has to be entered prior to each measurement on the photometer (e.g. volume, pH value or temperature)
- Check whether a value meets a condition.
With a condition you can check a value for validity (e.g. absorbance value, procedure variable or the result of a formula).
- Formula editor for the convenient programming of any user-defined methods

Special methods

The method list in the Special / Multi wavelengths mode comprises:

- preprogrammed multi wavelengths methods
- preprogrammed special methods
- special methods programmed by the user



If you program any special methods yourself, you can use all extended functions of the Special / Multi wavelengths mode.

4.7.2 Programming / modifying the Special / Multi wavelengths methods



For multi wavelength methods, you can use the method numbers 2001 to 2499. All special methods can also be selected in the method list of the concentration mode.

The creation of a user-defined method is done in the following steps:

- **Enter the general method data**
Method number, method name, unit etc.
- **Enter the wavelengths for absorbance measurements ($A_{x \text{ nm}}$)**
Minimum 1, maximum 10
- **Defining the procedure variables (K_X) (optional)**
Procedure variables are used to take into account any influence quantities that cannot be measured by the photometer.
The values for these procedure variables have to be entered for all measurements with the method, e.g. the temperature or pH value.
- **Enter the formula to calculate the measurement result**
Enter the formula with which you want to calculate the measurement result in the formula editor.
- **Enter an additional condition (optional)**
Conditions are used to check the measurement result for validity.
The condition is entered with the formula editor.

Example: Determination of chlorophyll-a according to Nusch

The chlorophyll determination is based on two measurements (before and after adding an acid) of the optical density (= absorbance) of the extract of an aqueous sample at 665 nm.

$$\text{Chlorophyll } a \text{ } (\mu\text{g/l}) = 29.6 * (A_{(\text{before}) 665 \text{ nm}} - A_{(\text{after}) 665 \text{ nm}}) * (V_{\text{Extract}} / V_{\text{Sample}})$$

with:

| | |
|--------------------------------------|--|
| $A_{(\text{before}) 665 \text{ nm}}$ | 1st absorbance measurement at 665 nm (before adding the acid) |
| $A_{(\text{after}) 665 \text{ nm}}$ | 2nd absorbance measurement at 665 nm (after adding the acid) |
| V_{Extract} | Volume of the extract (in ml) |
| V_{Sample} | Volume of the aqueous sample (in ml) |

Converted equation

For entry on the photometer, assign names that you can enter in the formula editor on the photometer to the variables of the equation.

$$R = 29.6 * (A_{665\text{nm}} - A_{665\text{nm}_2}) * (K_1/K_2)$$

with:

R (chlorophyll a (µg/l))

R = result (concentration chlorophyll A in µg/l)

$A_{x \text{ nm}}$ (= $A_{(\text{before}) 665 \text{ nm}}$)

Variables for absorbance.

These values are measured by the photometer.

$A_{x \text{ nm}_2}$ (= $A_{(\text{after}) 665 \text{ nm}}$)

Here: Two measurements at the same wavelength, at different points in time.

With several measurements (e.g. before and after adding the acid), the names of the variables differ in the index $_y$ added after an underscore (e.g. $A_{x \text{ nm}}$, $A_{x \text{ nm}_2}$, $A_{x \text{ nm}_3}$, etc.).

K_1 (= V_{Extract})

Procedure variables

K_2 (= V_{Sample})

K_1 = Volume of the extract (in ml)

K_2 = Volume of the aqueous sample (in l)

Numerals

Freely selectable numerical values

<HOME>

Special / Multi wavelengths

– [Setup]

|– Edit method

| | | |
|--------------------------|---------------|-------------------------|
| Edit method | | 16.01.15 9:52 |
| Number | 2001 | |
| Name | Chlorophyll a | |
| Version | 1.0 | |
| Citation form | Chl a | |
| Unit | µg/l | |
| Resolution | 0.1 | |
| Cell | 10 mm | |
| Lower limit of measuring | 0 µg/l | |
| Upper limit of measuring | 1000 µg/l | |
| | | |
| | | Method list Delete Next |

1 Enter the general method data here. The next available method number is already entered as the number.

You have the following options when filling out the input fields:

- Fill out all empty input fields one after the other
- Using *[Method list]*, select an already existing method as a model, give it a new method number and adjust the entries
- Using *[Method list]*, select an existing method in order to change it (without changing the number).
- You can delete the method completely with *[Delete]*.

2 Using *[Next]*, accept all entries on the page and switch to the next page.

| | | |
|--------------|--------|----------------------|
| Wavelength | | 16.01.15 9:52 |
| Wavelength 1 | 665 nm | |
| | | |
| | | Back Add Delete Next |

Enter the wavelengths for the absorbance measurements (A_x nm).

3 Add another wavelength with *[Add]*.

Delete a highlighted wavelength with *[Delete]*.

4 Using *[Next]*, accept all entries on the page and switch to the next page.

| | | |
|---|--|---------------|
| Procedure variables | | 16.01.15 9:52 |
| <p>Procedure variables are variables whose current numerical values have to be entered during the course of the measurement (e.g. weighted sample or dilution).</p> <p>If a procedure variable is required to calculate the result: Create a procedure variable (K) with <Add>.</p> | | |
| | | |
| | | Back Add Next |

Create all required procedure variables.

5 Create a procedure variable required for the formula with *[Add]* and enter a designation, e.g. the measured parameter.

or

Using *[Next]*, accept all entries and switch to the next page.

| Procedure variables | 16.01.15 9:52 |
|---------------------|---------------|
| K 1 | V (extract) |
| K 2 | V (sample) |

Back Add Delete Next

6 Add another procedure variable with *[Add]*.

or

Delete a highlighted procedure variable with *[Delete]*.

7 Using *[Next]*, accept all entries and switch to the next page.

| Formula entry | 16.01.15 9:52 |
|--|---------------|
| Use the <Operators> softkey to select an operation, function or constant (e.g.: +, -, *, tan, log, e, Pi). | |
| Use the <Variables> softkey to select an absorbance at a certain wavelength or a procedure variable. | |
| Enter numerals via the keyboard. | |
| You can erase the last entry with <◀>. | |

Back Operators Variables Next

Enter the formula.

8 Enter any numbers with <0...9>.

Use *[Operators]*, <▲ ><▼ > <◀ ><▶ > and <START·ENTER> to enter an operator, a function or a constant.

Use *[Variables]*, <▲ ><▼ > <◀ ><▶ > and <START·ENTER> to select a variable.

The formula is displayed after each step.

Using <◀ > you can delete the last element of the formula.

Use *[Back]* to quit the formula editor.

| Formula entry | 16.01.15 9:52 |
|-----------------------------------|---------------|
| Variables | |
| A(665 nm) | |
| K1 (V extract (ml)) K2 (V sample) | |

Back Operators Variables Next Back

9 Use *[Variables]*, <▲ ><▼ > <◀ ><▶ > and <START·ENTER> to select and confirm a variable. The current version of the formula is displayed.

| | | | |
|----------------------|---------------|-----------|------|
| Formula entry | 16.01.15 9:52 | | |
| R = 29.6 * (A665nm - | | | |
| Back | Operators | Variables | Next |

10 Add an operator.
The current version of the formula is displayed.

| | | | | |
|---|---------------|-----------|------|------|
| Formula entry | 16.01.15 9:52 | | | |
| <div style="border: 1px solid black; padding: 5px;"> Variables A(665 nm) K1 (V extract (ml)) K2 (V sample) </div> | | | | |
| Back | Operators | Variables | Next | Back |

11 Using [Variables], <▲ ><▼ > <◀ ><▶ > and <START-ENTER>, select and confirm variable A_{665 nm} for the second measurement. The current version of the formula is displayed.

| | | | | |
|---|---------------|-----------|------|------|
| Formula entry | 16.01.15 9:52 | | | |
| <div style="border: 1px solid black; padding: 5px;"> Variables A(665 nm) K1 (V extract (ml)) K2 (V sample (ml)) _ </div> | | | | |
| Back | Operators | Variables | Next | Back |

12 Using [Variables], <▲ ><▼ > <◀ ><▶ > and <START-ENTER>, select underscore (_). The input field pops up where you can enter an index for the measurement, e.g. 2 for the second measurement at this wavelength. Confirm the index entered. The current version of the formula is displayed.

| | | | |
|--------------------------------|---------------|-----------|------|
| Formula entry | 16.01.15 9:52 | | |
| R = 29.6 * (A665nm - A665nm_2) | | | |
| Back | Operators | Variables | Next |

13 Complete the formula.
The current version of the formula is displayed.

| | | | |
|----------------------------------|---------------|-----------|------|
| Formula entry | 16.01.15 9:52 | | |
| $R = 29.6 * (A665nm - A665nm_2)$ | | | |
| Back | Operators | Variables | Next |

14 Using *[Next]*, accept all entries and switch to the next page.

If an error is in the formula, an error message appears. The formula editor is only exited once the error is eliminated.

| | | | |
|---|---------------|-----------|------|
| Condition | 16.01.15 9:52 | | |
| <p>Here you can enter a formula for a condition. The measured value is only valid if this condition is met.</p> | | | |
| Back | Operators | Variables | Next |

If necessary, enter the formula for a condition.

15 Enter any numbers with **<0...9>**.

Use *[Operators]*, **<▲ ><▼ >** **<◀ ><▶ >** and **<START·ENTER>** to enter an operator, a function or a constant.

Use *[Variables]*, **<▲ ><▼ >** **<◀ ><▶ >** and **<START·ENTER>** to select a variable.

The condition is displayed after each step.

Using **<◀ >** you can delete the last element of the condition.

Use *[Back]* to quit the formula editor.

| | | | |
|-----------------------|---------------|--|------|
| Condition | 16.01.15 9:52 | | |
| $A665 \text{ nm} < 2$ | | | |
| b5 | | | |
| Back | | | Next |

16 Complete the condition.

17 Complete the programming of the method with *[Next]*.

| | |
|-------------|---------------|
| Edit method | 16.01.15 9:52 |
| Sequence | Designation |
| Measurement | _____ |
| Measurement | _____ |
| Back | Next |

If the formula includes several measurements at the same wavelength (measurement sequence), you can assign names to the individual measurements of the sequence.

18 Enter the names for the individual measurements of a sequence.

| | |
|-------------|---------------|
| Edit method | 16.01.15 9:52 |
| Sequence | Designation |
| Measurement | _____ before |
| Measurement | _____ after |
| Back | Next |

19 Complete the programming of the method with *[Next]*.

| | |
|--|---------------|
| Special / Multi wavelengths | 16.01.15 9:52 |
| V extract (ml) | |
| Press <START/ENTER> to enter the value | |
| 2001:Chl a 10 mm | Chlorophyll a |
| Setup | Method list |
| Citation form | Unit |

The method is programmed and selected.

The photometer is ready to measure.

4.7.3 Selecting a Special / Multi wavelengths method

To select a method for Special / Multi wavelengths measurements, proceed as follows:

```

<HOME>
Special / Multi wavelengths
└─ [Method list]
    
```

| | | | |
|----------------------|--------|--------------------|-------------------|
| Select method (all) | | 16.01.15 9:52 | |
| <input type="text"/> | | | |
| 2001 | Chl a | Chlorophyll a | µg/l |
| 2002 | Chl a | Chlorophyll a | mg/m ³ |
| 2503 | NO3 UV | NO ₃ -N | mg/l |
| Last used | | | |

The list of methods is displayed. The methods are ordered according to the method number.

Select the method:

- 1 Select the required method with <▲ ><▼ >. The active selection is displayed in reverse video.
- 2 Accept the selection with <START·ENTER>.

The photometer is ready to measure.

Narrowing down the method list

If the list is very long, you can narrow down the method list and thus make the search easier as follows:

- Using [*Last used*], you can restrict the method list to the ten methods last used.
- With the search function you can search certain character strings such as method number or test name in the list.

Search function

| | | | |
|-----------------------------------|-------|---------------|-------------------|
| Select method (last used) | | 16.01.15 9:52 | |
| <input type="text" value="Chl_"/> | | | |
| 2001 | Chl a | Chlorophyll a | µg/l |
| 2002 | Chl a | Chlorophyll a | mg/m ³ |
| All methods | | | |

Search for a character string:

Enter the character string to be searched for in the search window with <A...9>.

The list appearing below shows all hits containing the character string. The hit list is updated with each character that is entered.



Note the case sensitivity when searching.

4.7.4 Carrying out Special / Multi wavelengths measurements

<HOME>
Special / Multi wavelengths

| | |
|-------------------------------------|---------------|
| Special / Multi wavelengths | 16.01.15 9:52 |
| Please select method for measuring! | |
| Setup | Method list |
| Citation form | Unit |

1 Select the required method with [Method list] (see section 4.7.3).

For the description of the measuring procedure, the self-programmed method "Chl a" is selected as an example.

| | |
|--|--------------------------------------|
| Special / Multi wavelengths | 16.01.15 9:52 |
| V extract (ml) | |
| Press <START/ENTER> to enter the value | |
| 2001:Chl a 10 mm | Chlorophyll a 0.00 - 1000.00 µg/l |
| Setup | Method list |
| Citation form | |

For methods with procedure variables: Enter the values of all procedure variables one after the other.

2 Go on to the next step with <START-ENTER>.

| | |
|--|---------------|
| Special / Multi wavelengths | 16.01.15 9:52 |
| V extract (ml) 10 ml V sample (ml) 100 ml | |
| Proceed with <START/ENTER> | |
| 2001:Chl a 10 mm | Chlorophyll a |
| Setup | Repeat |
| | Cancel |

3 Follow the instructions on the display.

4 Enter the volumes of the sample and extract.

If necessary, repeat the last step with [Repeat].

5 Go on to the next step with <START-ENTER>.

The photometer is ready to measure.

| | |
|--|--------------------------------------|
| Special / Multi wavelengths | 16.01.15 9:52 |
| Measurement 1 | |
| Zero measurement required! Press <ZERO/BLANK> | |
| 2001:Chl a 10 mm | Chlorophyll a 0.00 - 1000.00 µg/l |
| Setup | Method list |
| Citation form | Unit |

If necessary, carry out a zero measurement.

| | |
|--|--------------------------------|
| Special / Multi wavelengths | 16.01.15 9:52 |
| <p>Measurement 1</p> <p>To start measurement, insert cell or press <START/ENTER></p> <p>2001:Chl a Chlorophyll a 10 mm</p> | |
| Setup | Method list Citation form Unit |

The photometer is ready to measure.

- 6 Go on to the next step with **<START·ENTER>**.

| | |
|--|---------------|
| Special / Multi wavelengths | 16.01.15 9:52 |
| <p>Measurement 1</p> <p>To start measurement, insert cell or press <START/ENTER></p> <p>2001:Chl a Chlorophyll a 10 mm</p> | |
| Setup | Cancel |

- 7 Insert the cell (rectangular or round) (see section 4.2.5 INSERTING A CELL).

- 8 Start the measurement.

| | |
|---|---------------|
| Special / Multi wavelengths | 16.01.15 9:52 |
| <p>V extract (ml) 10 ml V sample (ml) 100 ml Measurement 1 A(665 n) = 0.600</p> <p>Proceed with <START/ENTER></p> <p>2001:Chl a Chlorophyll a 10 mm</p> | |
| Setup | Repeat Cancel |

An intermediary result is displayed if there are several measurements.

- 9 Go on to the next step with **<START·ENTER>**.

| | |
|--|---------------|
| Special / Multi wavelengths | 16.01.15 9:52 |
| <p>Measurement 2</p> <p>To start measurement, insert cell or press <START/ENTER></p> <p>2001:Chl a Chlorophyll a 10 mm</p> | |
| Setup | Repeat Cancel |

- 10 Start the measurement.

| Special / Multi wavelengths | | 16.01.15 9:52 |
|---------------------------------------|------------------|---------------|
| V extract (ml) | 10 ml | |
| V sample (ml) | 100 ml | |
| Measurement 1 | A(665 n) = 0.600 | |
| Measurement 2 | A(665 n) = 0.000 | |
| 1.78 | | mg/ml |
| Start new analysis with <START/ENTER> | | |
| Setup | | Cancel |

The result is displayed.

If an entered condition is not met, no measured value is displayed.

- 11** If necessary, start a new measurement with the method.

4.8 OptRF measurement

4.8.1 General information

The OptRF measurement menu contains WTW methods for the optical reagent free measurement of some parameters in the UV range. The results - like those of WTW online measurements - are calculated by measuring and evaluating over a UV range between 200 and 390 nm. Therefore, a quartz cell is required for this measurement.

At the moment, the parameters are COD total, COD dissolved, NO₃ and NO₂ in the outlet of municipal waste water treatment plants, in standard operation without malfunctions. There is no photometric test set and no digestion of the sample required to perform a measurement.

save



COD dissolved: Always carry out OptRF measurements with the unfiltered sample even if the sample is filtered for the reference measurement.

The sample blank value is a characteristic of the sample (coloration) to be currently determined. It is diluted according to the used method but does not contain any color reagents.

The pH value corresponds to that of the test sample.

To achieve the highest accuracy possible and to exclude any interferences caused by the sample matrix, you should always carry out a user calibration to optimize the system for the relevant municipal waste water treatment plant.

To do so, the measured value is adjusted with reference values by means of suitable reference methods. This is done before the first usage and then at regular intervals or as necessary (user calibration, see section 4.8.5).



Basically, the methods can only be used for the specified application because the sample matrix and effects of the turbidity affect the measurement. For more detailed information, please refer to the application instructions for measurement in the analysis specifications.

4.8.2 Selecting OptRF measurement

Selecting the method last used

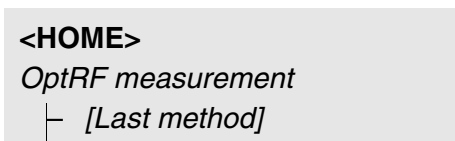

The method last used is immediately selected.

Selecting a method from the Method list

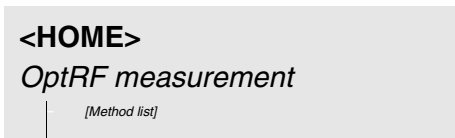

| | | | |
|------------------------------|------------------|--------------------|------------------|
| Select method (all) | | 16.01.15 9:52 | |
| Search: <input type="text"/> | | | |
| 3001 | CODt_H_Outlet_10 | COD | 0.0 - 75.0 mg/l |
| 3002 | CODs_H_Outlet_10 | COD | 0.0 - 75.0 mg/l |
| 3003 | NO3_H_Outlet_10 | NO ₃ -N | 0.0 - 3.0 mg/l |
| 3004 | NO2_H_Outlet_10 | NO ₂ -N | 0.00 - 4.00 mg/l |
| Last used | | | |

The list of methods is displayed. The methods are ordered according to the method number.

The method last selected is highlighted.

Select the method:

- 1 Select the required method with **<▲ ><▼ >**. The active selection is displayed in reverse video.
- 2 Accept the selection with **<START·ENTER>**.

Narrowing down the method list

You can narrow down the method list and thus make the search easier:

- Using *[Last used]*, you can restrict the method list to the ten methods last used.
- With the search function you can search certain character strings such as method number or test name in the list.

Search function

| | |
|---------------------------|-----------------------------------|
| Select method (last used) | 16.01.15 9:52 |
| NO3 | |
| 3003 NO3_H_Outlet_10 | NO ₃ -N 0.0 - 3.0 mg/l |
| 3002 CODs_H_Outlet_10 | COD 0.0 - 75.0 mg/l |
| All methods | |

Search for a character string:

Enter the character string to be searched for in the search window with **<A...9>**.

The list appearing below shows all hits containing the character string. The hit list is updated with each character that is entered.



Note the case sensitivity when searching. It is not required or possible to enter inferior characters.

4.8.3 Carrying out measurements

<HOME>
OptRF measurement

- 1 Select the required method with [Method list] (see section 4.7.3).

| | |
|--------------------------|---------------|
| OptRF measurement | 16.01.15 9:52 |
| Please select method for | |
| Setup | Method list |
| Citation form | |

| | |
|--|--------------------------------------|
| OptRF measurement | 16.01.15 9:52 |
| Zero measurement required! Press <ZERO/BLANK> | |
| 3003:NO3_H_Outlet 10 mm | NO ₃ -N 0.0 - 3.0 mg/l |
| Setup | Method list |
| Citation form | |

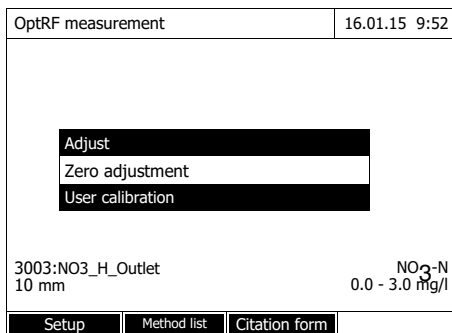

- 2 Using <ZERO-BLANK>, open the *Adjust* selection list.
- 3 Carry out a zero adjustment.
- 4 If necessary, perform a user calibration.

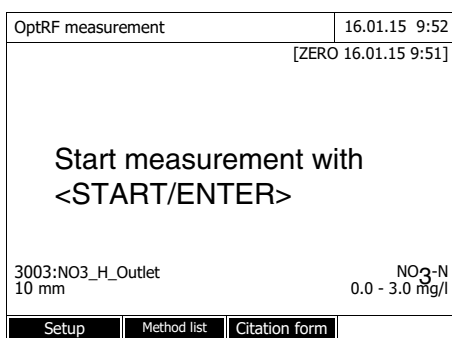

The photometer is ready to measure.

- 5 Further options:
 - Select a different citation form with [*Citation form*] (e.g. NO₃ ↔ NO₃-N).
 - Make further settings such as dilution or user calibration with [*Setup*].

| Setup | Menu item | Explanation |
|--------------|--------------------------------|--|
| | <i>Dilution</i> | <p>Here you can set the dilution prior to measuring if you want to use a diluted sample.</p> <p>In the measured value display, the dilution is indicated in the form [1 + x] (parts sample + parts distilled water).</p> <p>For more information, see section 4.8.4.</p> |
| | <i>User calibration</i> | <p>Here you can enter the value pairs (raw value [#] and corresponding reference value) for the method.</p> <p>For more information, see section 4.8.5.</p> |
| | <i>Measurement data memory</i> | <p>Access to the measurement data memory</p> <p>For more information, see section 4.12.</p> |

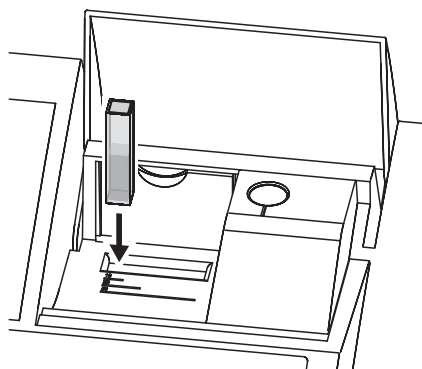

COD dissolved: Always carry out the OptRF measurement with the unfiltered sample even if the sample is filtered for the reference measurement.

6 Insert the cell.

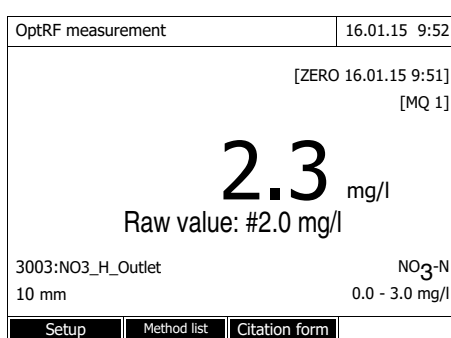

The result is displayed.

If no user calibration was carried out, the measured value (raw value) and the result of the measurement are identical. After a user calibration, the measured raw value and the result adjusted according to the calibration are displayed.

Rating number for the measured value quality (MQ):

- 1 - 3: Excellent - sufficient
- 4: Measured value invalid

7 Further options:

- Make further settings such as dilution or user calibration with [Setup].

8 If necessary, start a new measurement with the method.

| Possible errors | Remedy |
|----------------------------------|---|
| Absorption too high | Dilution |
| MQ value high (MQ = 2 or MQ = 3) | User calibration |
| MQ value too high (MQ = 4) | Use a matrix that is more suitable (sample unsuitable, dilute as necessary) |



A user calibration does not affect or change the evaluation number for the measured value quality. The user calibration just optimizes the calculated concentration values.

4.8.4 Setting the dilution

If the concentration of a sample exceeds the measuring range of a method, you can specifically dilute the sample so that the concentration of the diluted sample is in the measuring range of the method. Thus a valid measurement is possible.

After entering the factor for the dilution the meter converts the concentration to that of the undiluted sample.



The displayed measuring range of the method changes with the entered dilution factor. The measuring range is no longer displayed after the dilution factor was entered.

Optimum measurement results are achieved if the concentration of the diluted sample is in the middle of the original measuring range of the method (without entering a dilution factor).

Setting the dilution

<HOME>
OptRF measurement

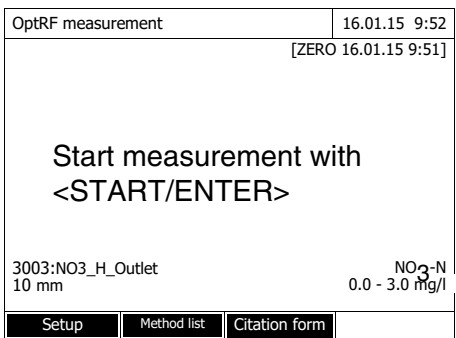

- 1 Select a reagent free method and carry out the zero measurement (see 4.8.3section 4.8.3)

The photometer is ready to measure.

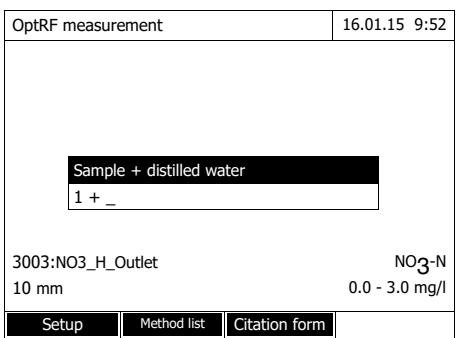

- 1 Open the setting menu with [Setup].
- 2 Select and confirm Dilution. The input field for the dilution pops up.
- 3 Enter and confirm the dilution (<0...9>).

The entered dilution is taken into account with the next measurement.

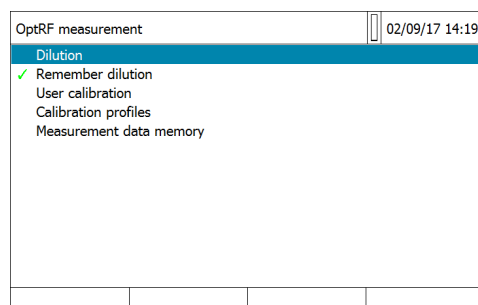

If a dilution factor once set for a method or calibration profile should be stored and used for further measurements:

- 1 Open the setting menu with [Setup].
- 2 Select and confirm *Remember Dilution*.

If the option *Dilution* is not selected, the dilution factor is erased if:

- the photometer is switched off
- the OptRF menu is exited
- a different method is selected
- the factor 0 is entered in the *Dilution* menu.

If a dilution factor is active, it is indicated on the display during measurement in the form [1 + x].

4.8.5 User calibration

For optical reagent free methods, a user calibration should be carried out for the required parameters so the system is optimally adapted to the matrix of the relevant waste water treatment plant.

Calibration points and value pairs

The adjustment is carried out at one or two points within the measuring range. A value pair is determined at each point. Each value pair consists of the raw value of the sample and the corresponding reference value. The reference value is determined from the same sample using a suitable reference method (e.g. conventional test sets).

Selection of calibration points

If the required accuracy is low, the default setting of the first value pair can be adopted unchanged. The first value pair is equivalent to the zero point in this case. The second value pair should be close to the working point of the application. This method results in a single-point calibration.

If the application has to cover a wide value range with high measuring accuracy, both value pairs should be used for calibration. When doing so, the calibration value pairs should be determined and input at the limits of the application range.



The measurement results will be ever more accurate the closer the composition of the test sample corresponds to the status at the time of the calibration. If there is a fundamental change of the characteristics of the sample, a new calibration is required.

The implementation of the user calibration is documented together with the measured value and indicated in the measured value display by [Cal]. Every user calibration is given an ID. This ID is a consecutive number and stored (example: [Cal: 4]).

Validity

A user calibration applies to the method currently called up. A user calibration is only erased if

- a new user calibration is carried out
- the original calibration is selected for measurement
- the user calibration is erased manually
- the photometer is reset to the default condition.

Performing a user calibration

Select a sample for the user calibration that represents the real application conditions as well as possible. Determine the concentration of the required parameters of this sample promptly with OptRF measurements and with a suitable reference measurement.

The user calibration comprises the following steps:

- Carry out the reference measurement:
Determine the concentration of the required parameter for this sample with a reference method.
- Carry out the *OptRF measurement*:
Determine the concentration of the required parameter for this sample with the *OptRF measurement* method.
- Enter the value pairs for *OptRF measurement* (raw value) and corresponding reference value on the photometer.

Reference measurement

- 1 Measure your sample with a reference method of your choice. Measure your sample in the lower and upper concentration range to be expected and note down the measured values (reference values).
Then measure the sample with a method in the menu *OptRF measurement*.

OptRF measurement

<HOME>
OptRF measurement

- 2 Select the method and carry out the zero measurement (see section 4.8.3)

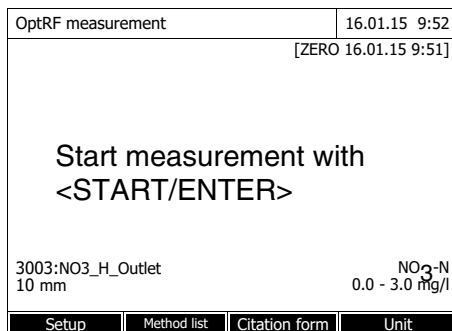

The photometer is ready to measure.

- 3 Use the same samples as for the reference measurement and note down the raw values measured.

COD dissolved: Always carry out the OptRF measurement with the unfiltered sample even if the sample is filtered for the reference measurement.

Entering the value pairs

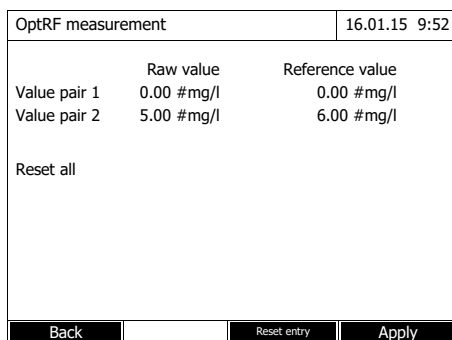

- 4 Open the setting menu with [Setup].

- 5 Select and confirm *User calibration*.

The data currently used (factory calibration or the calibration values last entered) are displayed as value pairs (Raw value and reference value) for two calibration points.

- 6 Select a value with <▲ ><▼ > and open it for editing with <START·ENTER>
- 7 Enter a value (<0...9>) and confirm with <START·ENTER>.
- 8 Complete all four values.
- 9 Confirm the values of the user calibration with [Apply].

| | |
|--------------------------------------|--------------------------------------|
| OptRF measurement | 16.01.15 9:52 |
| [ZERO 16.01.15 9:51] | |
| Start measurement with <START/ENTER> | |
| 3003:NO3_H_Outlet 10 mm | NO ₃ -N 0.0 - 3.0 mg/l |
| Setup | Method list |
| Citation form | Unit |

The photometer is ready to measure.

4.9 Spectrum

4.9.1 General information

With the *Spectrum* function, the *Absorbance* or *Transmission* in dependency of the wavelength is measured and recorded. The wavelength range can be freely selected within the measuring range of the photometer. The increment is 1 nm.

A spectrum is recorded without using any methods or profiles. All settings are configured during measurement.

Baseline

Before a spectrum is recorded, a baseline has to be recorded using a suitable zero cell, e.g. with deionized water. The baseline has to cover at least the wavelength range of the spectrum to be recorded. Once the baseline is measured, it remains stored in the photometer until

- a new baseline is recorded
- the wave length range is extended in the *[Setup]* menu
- the *Spectrum* mode is exited or the photometer is switched off

Settings

You can record a spectrum with standard settings without opening the setting window.

The following settings are possible for a spectrum:

| Input field | Possible entries |
|-------------------------|---|
| <i>Wavelength start</i> | 190* ... 1100 nm |
| <i>Wavelength stop</i> | 190 ... 1100* nm |
| <i>Mode</i> | <i>Absorbance*</i> or <i>Transmission</i> |
| <i>Smoothing</i> | <i>Yes*</i> or <i>No</i> |
| <i>Color of graph</i> | Color selection for the curve |
| <i>Scaling</i> | <i>Auto*</i> or <i>Manual</i> |

| Input field | Possible entries |
|--|---|
| <i>Scaling: Auto*</i> | During measurement, the instrument adjusts the axis scaling (minimum and maximum value of the axis) to the measured values. The entire curve is always visible. |
| <i>Scaling: Manual</i> <i>Y-axis min</i> <i>Y-axis max</i> | The axis scaling (minimum and maximum value of the axis) is set manually. |

* default setting



You can store the current settings as a profile with *[Save]*.
 You can load a stored profile with *[Open]*.
 Profiles for spectra have the file extension, ".profil".

4.9.2 Recording the Spectrum

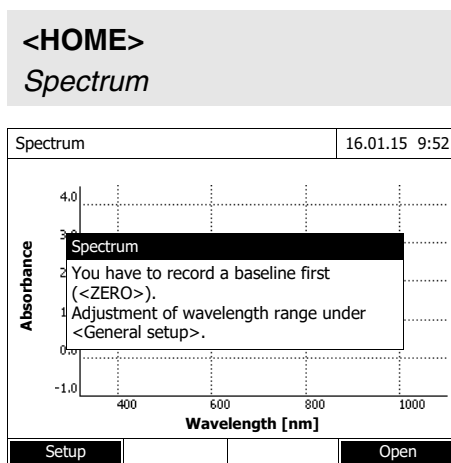

A message containing operating instructions is displayed.

- 1 Open the setting menu with *[Setup]*.

| | |
|------------------|---------------|
| Spectrum | 16.01.15 9:52 |
| Wavelength start | |
| Wavelength stop | 1100 nm |
| Mode | Absorbance |
| Smoothing | Yes |
| Color of graph | Blue |
| Scaling | Auto |
| Apply | |

- 2 If necessary, change the standard settings for the spectrum.
 - Wavelengths for start point and end point of the spectrum to be recorded
 - Representation mode (*Absorbance / Transmission*)
 - Smoothing of the curve (*Yes/ No*)
 - Color of the curve
 - Scaling of the Y-axis
Auto: (entire value range)
Manual: (selected value range)

3 Accept all entries with [Apply].

A message containing operating instructions is displayed.

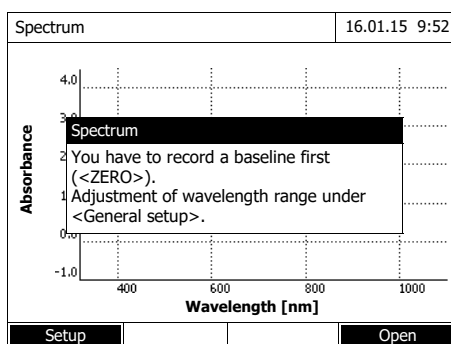

Recording the baseline:

- 4 Press the <ZERO-BLANK> key. The photometer records the baseline.
- 5 Wait until the baseline is completely recorded.

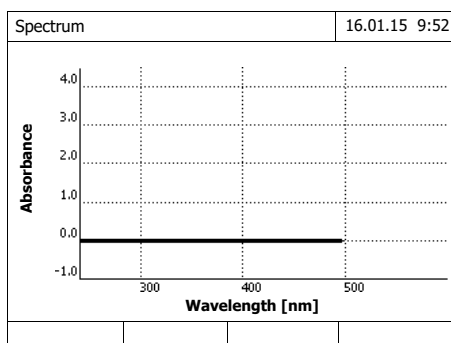

The photometer is ready to measure after the baseline has been recorded.

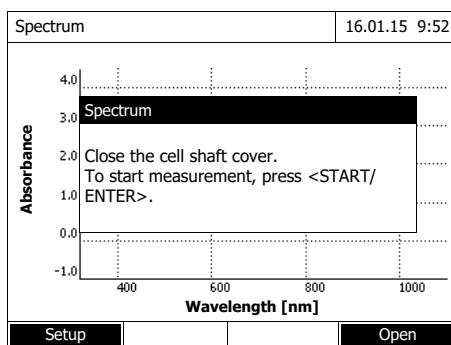

Recording the spectrum:

- 6 Insert the cell (rectangular or round) (see section 4.2.5 INSERTING A CELL).
- 7 Start the measurement with **<START·ENTER>**.

After the spectrum has been recorded, the following message appears: *Recording of spectrum is completed..*

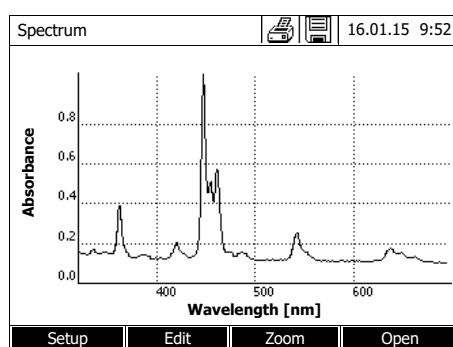

Cursor information

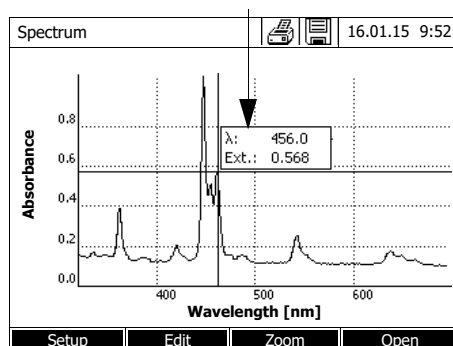

- 8 Wait until the spectrum is completely recorded.

At the end of the recording the following message appears: *Recording of spectrum is completed.*

- 9 Confirm the message with **<START·ENTER>**.

The cursor appears at the absolute maximum of the spectrum.

- 10 You have the following options:

- Immediately edit the spectrum (see section 4.9.3)
- With **<PRINT>**, you can output the spectrum to a connected printer as a graphic or a pdf file.
- You can save the spectrum as a *.csv file with **<STORE>**. As the storage location, you can select the photometer (*Internal DataB folder*) or a USB memory device connected to the USB-A connection (*USB memory*). Stored spectra can be recalled and edited at any time (see section 4.9.3).

4.9.3 Loading/editing a spectrum

A spectrum can be edited immediately after measurement. Stored spectra can be loaded and edited as well.

The following tools are available for editing:

- Cursor function for incremental moving along the curve with indication of the x and y values
- Zoom function to scale up a section
- Mathematical functions for various evaluating and calculating operations. The functions are described from page 97.

Loading a stored spectrum

<HOME>
Spectrum
– [Open]

| Open (Internal DataB folder) | | 16.01.15 9:52 |
|------------------------------|-------------------|---------------|
| 26.02.07 | Holmium.csv | |
| 23.02.07 | K2Cr2O7_340nm.csv | |

Location Delete

The list with the spectra stored in the exchange memory is displayed.

- 1 If necessary, you can select a different memory location for the spectrum with *[Location]* (USB memory device at the USB-A connection).
- 2 Select the required spectrum.

The original view of the curve is displayed.

Cursor

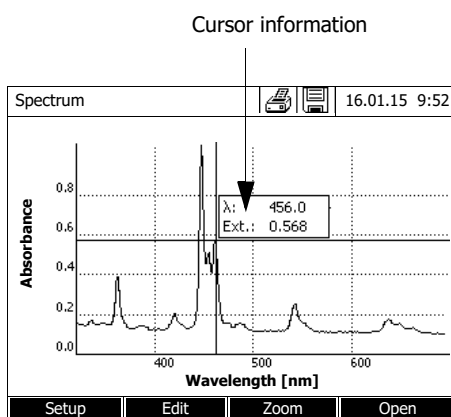

The cursor consists of a horizontal and vertical line that cross each other on a point of the curve. A box names the x and y values of the point of the curve.

Move the cursor along the x axis (wavelength) with << >>. You can scan and evaluate the curve point after point.

Zoom

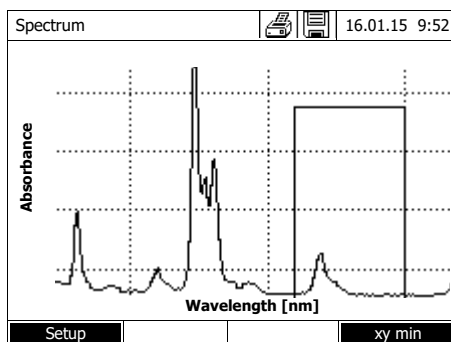

1 Press [Zoom].

The zoom window appears. The bottom left corner of the zoom window is marked by a small black square.

- You can return to the original view of the spectrum with [Original] at any time.

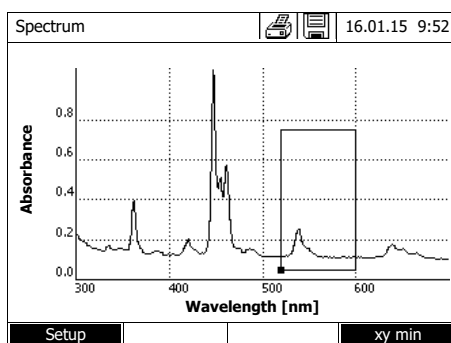

2 Adjusting the zoom window:

- Define the bottom left corner of the zoom window with <<◀ >>▶ > and <▲ ><▼ >.

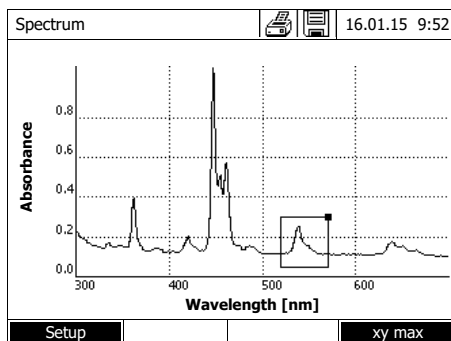

- Use [xy max] to mark the top right corner of the zoom window (small black square).
- Define the top right corner of the zoom window with <<◀ >>▶ > and <▲ ><▼ >.

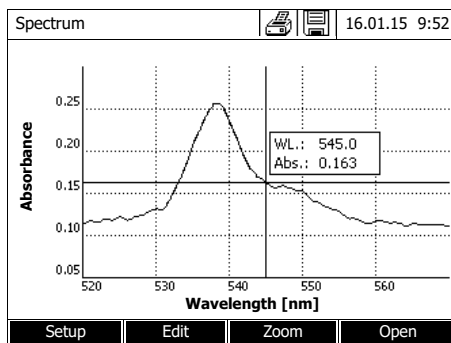

3 Scaling up the zoom window:

- Press the <START·ENTER> key. The zoom window is scaled up on the entire diagram area.

Leaving the zoom view:

- You can return to the original view of the spectrum with <ESC> at any time.

- Edit** Open the selection of mathematical functions with *[Edit]*:
- *Extreme values (zoomed area)*
Highlights the extreme values (minimum and maximum values) of the displayed spectrum.
 - *Mark points*
Opens an edit mode where you can highlight individual points of the spectrum.
With the *[Mark]* function key you can highlight individual points.
The wavelength and measured value are displayed at the highlighted point.
With the *[Delete]* function key you can remove individual points.
 - *Delete all marks*
Erases all highlighted points in the spectrum.
 - *Original*
Displays the original, unedited spectrum.
 - *Integral*
Calculates the area between the zero line and curve within a freely selectable wavelength interval $[X1, X2]$.
 - *Derivative*
Calculates the derivative of the total spectrum. To calculate the second and third derivative, the function can be carried out several times.
 - *Compare spectrum*
Loads a second spectrum into the same diagram for direct comparison. The second spectrum is displayed in the color magenta.
 - *Add spectrum*
Adds a stored spectrum to the current spectrum.
 - *Subtract spectrum*
Subtracts a stored spectrum from the current spectrum.
 - *Divide spectrum (ratio)*
Divides the absorbance or % transmission values of the current spectrum by the values of a stored spectrum
 - *Add fixed value*
Adds a constant absorbance or % transmission value to the current spectrum.
 - *Multiply fixed value*
Multiplies the absorbance or % transmission values of the current spectrum by a constant value.



The addition, subtraction and division of two spectra always applies to the common wavelength range of both spectra only.

4.9.4 Saving / exporting a spectrum

The saving of a spectrum saves both the edited and the original spectrum. Consequently, the original spectrum can be restored from each stored spectrum.

Saving

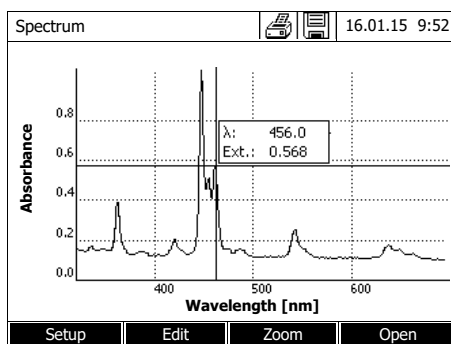

- 1 Record a spectrum (see section 4.9.2)
or
Load a stored spectrum (see section 4.9.3).
- 2 If necessary, connect a USB memory device to the USB-A interface.
- 3 Open the save dialog with **<STORE>**.
- 4 If necessary, change the storage location with *[Location]*:
Internal DataB folder:
Exchange folder in the instrument
or
USB memory:
USB memory device connected at the USB-A connection.
- 5 If necessary, change the file name.
The photometer automatically suggests an unambiguous file name consisting of the wavelength range, date and time.
- 6 Save the file with **<START·ENTER>**.

Export to a PC Export a stored spectrum to a PC: see section 4.15

4.10 Kinetics

The Kinetics function enables the temporal tracing of the absorbance or transmission of a sample at a certain wavelength.

The photometer automatically calculates the slope between two adjacent measuring points from the available measurement data.

The catalytic activity can also be determined and displayed if required.

To record the kinetics, the photometer carries out single measurements at regular intervals (measuring interval) and stores the measured values as a time function.

All settings for a recording are administrated as a profile. Profiles can be created, stored, edited and deleted. Each measurement requires a respective profile.

4.10.1 Creating/editing profiles for Kinetics recordings



Profiles for Kinetics records are stored under the numbers 4001 to 4020.

In the delivery condition, a profile is stored for demonstration purposes.

A profile for a Kinetics recording comprises the following data:

| Input field | Possible entries |
|---------------------|---|
| <i>Number</i> * | 4001 ... 4020 |
| <i>Name</i> | Any name (max. 18 characters) |
| <i>Mode</i> * | <i>Absorbance</i> or <i>Transmission</i> |
| <i>Wavelength</i> * | Freely selectable (in nm) |
| <i>Duration</i> * | Total duration in the format hh:mm:ss (hours:minutes:seconds) |
| <i>Interval</i> * | Measuring interval = time interval between two successive single measurements in the format hh:mm:ss (hours:minutes:seconds) Exception: With the setting, <i>Measurements/interval: Max/interval</i> the interval is defined differently (see below). |
| <i>Delay</i> | Time between the start of the recording and the start of the first single measurement |

| Input field | Possible entries |
|---|--|
| <i>Scaling</i> | <i>Auto</i> or <i>Manual</i> |
| <i>Scaling: Auto</i> ** | During measurement, the instrument adjusts the axis scaling (minimum and maximum value of the axis) to the measured values. The entire curve is always visible. |
| <i>Scaling: Manual</i> <i>Y-axis min</i> <i>Y-axis max</i> | The axis scaling (minimum and maximum value of the axis) is set manually. |
| <i>Measurements/interval</i> | <i>1/interval</i> or <i>Max/interval</i> Here you define how many measurements are carried out per interval. This setting has an impact on the calculation of the slope of the individual intervals (see section 4.10.6). |
| <i>Catalytic activity</i> (only with <i>Mode: Absorbance</i>) | <i>Yes</i> or <i>No</i> Here you determine whether the catalytic activity should be calculated. The catalytic activity is a measure for the amount of substance that is converted per time unit. To accelerate the substance conversion, a catalyst or enzyme (biological catalyst) is used in most cases. Carry out this measurement at room temperature. |
| <i>Catalytic activity: Yes</i> <i>Factor</i> <i>Unit</i> <i>Resolution</i> | The catalytic activity or enzymatic activity is calculated from the slope of the curve. <div style="border: 1px solid black; padding: 2px; width: fit-content; margin: 5px 0;">$\text{Cat. A.} = \text{mean value Slope } [\Delta / \text{min}] * \text{Factor}$</div> Here you can enter the value for <i>Factor</i> . The calculated value for the catalytic activity is displayed in the menu, <i>[Edit] / Slope & catalytic activity</i> , together with the unit and resolution selected here. |

* necessary inputs

** default: *Auto*

Creating/editing a profile

```
<HOME>
Kinetics
  - [Setup]
    |
    | Edit profile
```

| Edit profile (1 of 2) | | 16.01.15 9:52 |
|---|------------|---------------|
| Number | 4001 | |
| Name | NADH | |
| Mode | Absorbance | |
| Wavelength | 340 nm | |
| Duration | 02:00:00 | |
| Interval | 00:00:30 | |
| Delay | 00:01:00 | |
| Scaling | Auto | |
| <input type="button" value="Profile list"/> <input type="button" value="Delete"/> <input type="button" value="Next"/> | | |

1 Enter the data for the profile here. The next available profile number is already entered as the number.

You have the following options when filling out the input fields:

- Fill out all empty input fields one after the other
- Using *[Profile list]*, select an already existing profile as a model, give it a new profile number and adjust the entries
- Using *[Profile list]*, select an existing profile in order to change it (without changing the number).
- You can delete the profile completely with *[Delete]*.

2 With *[Next]* you can switch to further settings.

| Edit profile (1 of 2) | | 16.01.15 9:52 |
|---|------------|---------------|
| Measurements/interval | 1/interval | |
| Catalytic activity | Yes | |
| Factor | 1.000 | |
| Unit | cat | |
| Resolution | 0.01 | |
| <input type="button" value="Back"/> <input type="button" value="Complete"/> | | |

3 Enter further data for the profile here.

4 Accept all entries with *[Complete]*.

The profile is created and selected. The photometer is ready to measure.



The *Catalytic activity* function is only available if the Absorbance mode was selected.

4.10.2 Loading a profile for Kinetics recording

To load a profile for Kinetics recording, proceed as follows:

```
<HOME>
Kinetics
├─ [Profile list]
```

| Select profile (all) | | 16.01.15 9:52 | |
|----------------------|------|---------------|--|
| <input type="text"/> | | | |
| 4001 | NADH | Absorbance | |
| 4002 | A740 | Absorbance | |
| | | | |
| Last used | | | |

The list of profiles is displayed. The profiles are ordered according to the profile number.

Selecting a profile:

- 1 Select the required profile with **<▲ ><▼ >**. The active selection is displayed in reverse video.
- 2 Accept the selection with **<START-ENTER>**.

The photometer is ready to measure.

Narrowing down the list of profiles

If the list is very long, you can narrow down the profile list and thus make the search easier as follows:

- Using *[Last used]*, you can restrict the profile list to the ten profiles last used.
- With the search function you can search certain character strings such as method number or test name in the list.

Search function

| Select profile (last used) | | 16.01.15 9:52 | |
|----------------------------------|------|---------------|--|
| <input type="text" value="NA_"/> | | | |
| 4001 | NADH | Absorbance | |
| | | | |
| All profiles | | | |

Search for a character string:

Enter the character string to be searched for in the search window with **<A...9>**.



Note the case sensitivity when searching.

4.10.3 Recording the Kinetics

<HOME>
Kinetics

| | |
|--|---------------|
| Kinetics | 16.01.15 9:52 |
| Zero measurement required! Press <ZERO/BLANK> | |
| 4001: Demo | Absorbance |
| Setup | Profile list |
| | Open |

- 1 If necessary, select a different profile with [Profile list] (see section 4.10.2).
- 2 Start the zero measurement with <ZERO·BLANK>.

| | |
|---|-----------------|
| Kinetics | 16.01.15 9:52 |
| Please insert zero cell (distilled water) or press <START/ENTER> | |
| 10 mm | 0.0 - 22.1 mg/l |
| Setup | Profile list |
| | Open |

- 3 Carry out the zero measurement.

| | |
|---|-----------------|
| Kinetics | 16.01.15 9:52 |
| [ZERO 16.01.15 9:51] | |
| Close the cell shaft cover. To start measurement, press <START/ ENTER>. | |
| 10 mm | 0.0 - 22.1 mg/l |
| Setup | Profile list |
| | Open |

The photometer is ready to measure.

- 4 Insert the cell (see section 4.2.5 INSERTING A CELL).
- 5 Start the measurement with <START·ENTER>.

The photometer starts recording automatically.

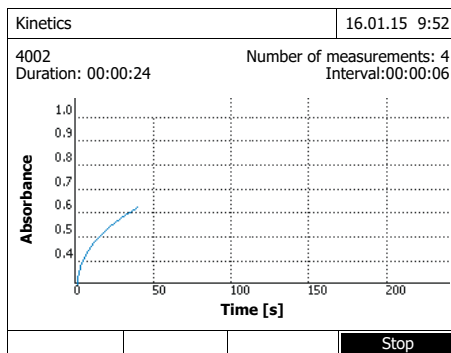

6 Wait until the recording is finished.

Stopping the recording:

- Use *[Stop]* to terminate the recording prematurely. The curve recorded up to this point can be stored and edited (see section 4.10.6).
- Use **<ESC>** to completely cancel measurement. The curve recorded up to this point is discarded.

Cursor information

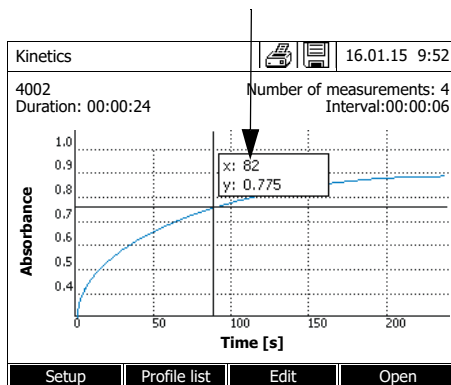

7 After the specified *Duration* has expired, the cursor appears.

You have the following options:

- You can move the cursor along the curve and have the measurement data for each point displayed (see section 4.10.6)
- With **<PRINT>**, you can output the kinetic curve to a connected printer as a graphic or a pdf file.
- You can store the kinetic curve with **<STORE>** (see section 4.10.4).
- Execute further functions to edit the kinetic record (see section 4.10.6)
- Close the kinetic record with **<ESC>**.

4.10.4 Saving / exporting a Kinetics record

Saving

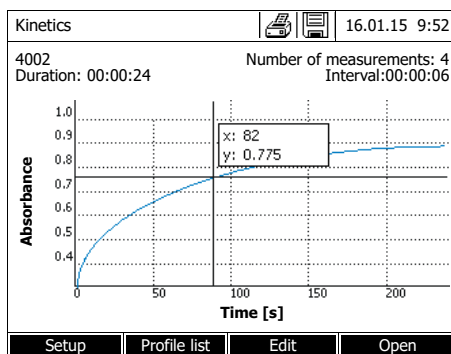

- 1 Carry out the kinetic recording (see section 4.10.3) or Load a stored kinetic record (see section 4.10.4).
- 2 If necessary, connect a USB memory device to the USB-A interface.
- 3 Open the save dialog with **<STORE>**.
- 4 If necessary, change the storage location with *[Location]: Internal DataB folder*. Exchange folder in the instrument or *USB memory*: USB memory device connected at the USB-A connection.
- 5 If necessary, change the file name.
- 6 Save the file with **<START·ENTER>**.

Export to a PC

Export a stored kinetic record to a PC: see section 4.15

Example of a kinetic recording (*.csv file)

```
6|4001|1|1|525|1280913092|59|5|1|0.000|0.301|0|1.000|µkat|2
Device: Serial number:Software: User:
photoLab 7600 UV-VIS 09130512 1.30-WTW-1.60 Administrator

Start time Wavelength [nm]
04.08.2010 11:11 525

Time [s] Absorbance
0 0,092
5 0,077
10 0,073
15 0,069
.. .....
```

Line 1 - explanations:

| Col. | Value | Explanation |
|------|------------|---|
| 1 | 6 | Version of the file format for the CSV file |
| 2 | 4001 | Profile number |
| 3 | 1 | Measurement of absorbance (0) or transmission (1) |
| 4 | 1 | Measurement once per interval (0) or as often as possible (1) |
| 5 | 525 | Wavelength (in nm) |
| 6 | 1280913092 | Start time (internal data format) |
| 7 | 59 | Duration (in sec) |
| 8 | 5 | Interval time (in sec) |
| 9 | 1 | Scaling automatic (0) or manual (1) |
| 10 | 0.000 | Minimum for manual scaling |
| 11 | 0.301 | Maximum for manual scaling |
| 12 | 0 | Enzymatic activity Off (0) or On (1) |
| 13 | 1.000 | Factor for enzymatic activity |
| 14 | µkat | Unit of enzymatic activity |
| 15 | 2 | Decimal points for enzymatic activity |

4.10.5 Loading a Kinetics record

You can load and view stored Kinetics records.

Loading a stored Kinetics record

```
<HOME>
Kinetics
- [Open]
```

| | | 16.01.15 9:52 |
|----------|-------------------------------|---------------|
| 26.02.07 | Enzyme kinetics.csv | |
| 24.02.07 | A740.csv | |
| 24.02.07 | kinetics_4002_070224_1410.csv | |
| Location | Delete | |

The list with the stored Kinetics records is displayed (*Internal DataB folder*).

- 1 With *[Location]* select the memory location of the kinetic record (*Internal DataB folder* or *USB memory* for a USB memory device at the USB-A connection).
- 2 Select the required Kinetics record.

The curve is loaded.

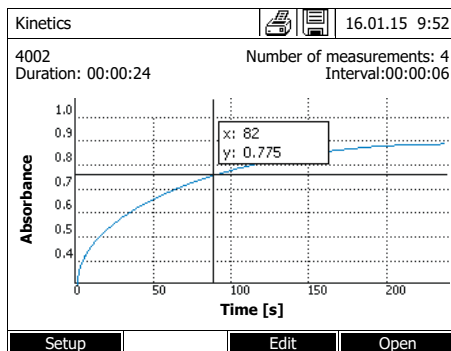

You have the following options:

- You can move the cursor along the curve and have the measurement data for each point displayed (see section 4.10.6)
- With **<PRINT>**, you can output the kinetic curve to a connected printer as a graphic or a pdf file.
- You can store the kinetic curve with **<STORE>** (see section 4.10.4).
- Execute further functions to edit the kinetic record (see section 4.10.6)
- Close the kinetic record with **<ESC>**.

4.10.6 Editing a Kinetics record

The following functions are available for kinetic records:

- Moving along the curve with the cursor
- Displaying a list with the slopes of the curve for each interval
- Scaling the Y-axis of the diagram
- Combined display of two kinetic records in one graphic
- Display of the difference of two kinetic records

Cursor

Cursor information

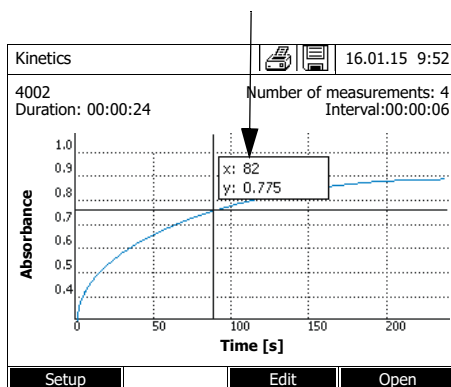

The cursor consists of a horizontal and vertical line that cross each other on a point of the curve. A box names the x and y values of the point of the curve.

Move the cursor along the x axis (time axis) with **<◀ >▶ >**. You can scan and evaluate the curve point after point.

Slope of the curve & catalytic activity

The function, *Slope & catalytic activity* indicates the slope of the kinetic curve in the individual intercepts (intervals) of the curve. An intercept corresponds to the *Interval* entered in the profile.

- 1 Indicate the slope of the kinetic curve in the individual intercepts (intervals) of the curve with *[Edit]/ Slope & catalytic activity*.

If the calculation of the catalytic activity was selected when the profile was created it is displayed here together with the slope.

| Interval | Slope [Δ /min] (Δ) | Time |
|----------|-------------------------------------|------|
| 1 | 0.000 | 5 s |
| 2 | 0.000 | 10 s |
| 3 | 0.000 | 15 s |
| 4 | 0.000 | 20 s |
| 5 | 0.000 | 25 s |
| 6 | 0.000 | 30 s |



The *Slope & catalytic activity* function is only available if the kinetic recording was done in the Absorbance mode.

The displayed slope for an interval is determined as follows, depending on the slope:

| <i>Measurements/interval</i> | Slope |
|------------------------------|---|
| <i>1/interval</i> | Slope, converted to the interval, "1 minute" |
| <i>Max/interval</i> | Slope of the straight line determined by linear regression in an interval, converted to the interval "1 minute" |

Scaling of the Y-axis

You can manually determine the scaling of the Y-axis with *[Setup]/Scaling/Manual*.

Compare kinetics

For direct comparison, you can load a second kinetic record into the same diagram with *[Edit]/ Compare kinetics*.



The *Compare kinetics* function can only be carried out if both kinetic records were made in the Absorbance mode.

Subtract kinetics

You can subtract a stored kinetic record from the current kinetic record with *[Edit]/ Subtract kinetics*.



The *Subtract kinetics* can only be carried out if both kinetic records were made with the following settings:

- Mode: Absorbance
- Measurements/interval: 1/interval
- Equal interval

4.11 Timer

You can use the timers to remind you by an acoustic signal of a time interval that has expired.

The photometer has two types of timers:

- The *User defined timer* is a timer that can be freely assigned. The interval and name can be freely set. Only one freely assignable timer is available. It cannot be erased (see section 4.11.1).
- *Analysis timer* are timers permanently stored in the photometer. The names and intervals of the analysis timers are stored in the method data of a measuring method (*Concentration* mode). The number of available analysis timers corresponds to the number of reaction times prescribed in the analysis instructions of the programmed methods (see section 4.11.2).

The photometer administrates all timers in the timer overview.

The timer overview (the *Timer* menu) is opened with the **<TIMER>** key. The *Timer* menu can be opened from any operating situation. Operation of the timer does not disturb any other functions. The timer overview can be exited with the **<ESC>** key.

When the *Timer* menu is opened for the first time, only the user-defined timer is in the timer overview. You can include analysis timers into the list or remove them according to your requirements (see section 4.11.2).

The timer overview displays the status of each timer and, of a started timer, the remaining time of the specified time interval.

All timers are started manually.

As soon as one single timer has been started the timer symbol appears on the display in all operating modes.

As soon as a timer is started, it is given the timer status *Active*.

When the specified time interval has expired, the timer status changes from *Active* to *Expired* and an audio signal sounds.

In the timer status *Expired* the acoustic signal sounds until the timer is stopped manually.

After the stop, the timer status changes to *Inactive* and the acoustic signal is

switched off.

4.11.1 User defined timer

If you want to manually enter time intervals, use the *User defined timer* function.

<TIMER>

| Timer | | 16.01.15 9:52 |
|--------------------|----------|---------------|
| Designation | Time | Status |
| User defined timer | 00:15:00 | Inactiv |
| A6/25 - 1 | 00:15:00 | Inactiv |

Start Stop Edit Add

The *Timer* menu is open.

- 1 Highlight the *User defined timer*.
- 2 If necessary, change the name and time of the timer with *[Edit]*.
- 3 Start the highlighted timer with *[Start]*.

The status of the timer is *Active*. When the specified time interval has expired, and audio signal sounds and the timer status changes to *Expired*.

- 4 Stop the highlighted timer with *[Stop]*.

The status of the time changes to *Inactive*. The audio signal is switched off.

4.11.2 Analysis timer

Between the individual steps of a measurement, reaction times often have to be observed. The length of the reaction time is defined in the relevant analysis instructions.

For all required reaction times, the analysis timers with the corresponding time intervals are stored in the instrument. The names of the analysis timers include the method name and a current number so several timers within a method can be distinguished from each other.

To be able to use an analysis timer for a method you have to load it first in the timer overview.

To do so, first select the required method and then add the available analysis timers to the timer overview so they can be started as necessary.

The timer overview always comprises the free timer and the selected analysis

timers.

<TIMER>

| | | |
|--|---------------|---------|
| Timer | 16.01.15 9:52 | |
| Designation | Time | Status |
| User defined timer | 00:15:00 | Inactiv |
| A6/25 - 1 | 00:15:00 | Inactiv |
| <div style="display: flex; justify-content: space-around; margin-top: 10px;"> Start Stop Remove Add </div> | | |

- 1 Select the required method in the *Concentration* mode.

Manual selection of the method (see section 4.5.5).

- 2 Open the Timer menu.

The *Timer* menu is open.

- 3 If necessary, add a new timer to the list with *[Add]*.

Note:

The *[Add]* function key is only displayed if a method is selected for which analysis timers were programmed but are not yet displayed in the list of timers.

- 4 Highlight an analysis timer.
- 5 If necessary, remove the analysis timer from the list with *[Remove]*.
- 6 Start the highlighted timer with *[Start]*.

The status of the timer is *Active*. When the specified time interval has expired, and audio signal sounds and the timer status changes to *Expired*.

- 7 Stop the highlighted timer with *[Stop]*.

The status of the time changes to *Inactive*. The audio signal is switched off.

4.12 Memory

4.12.1 Overview

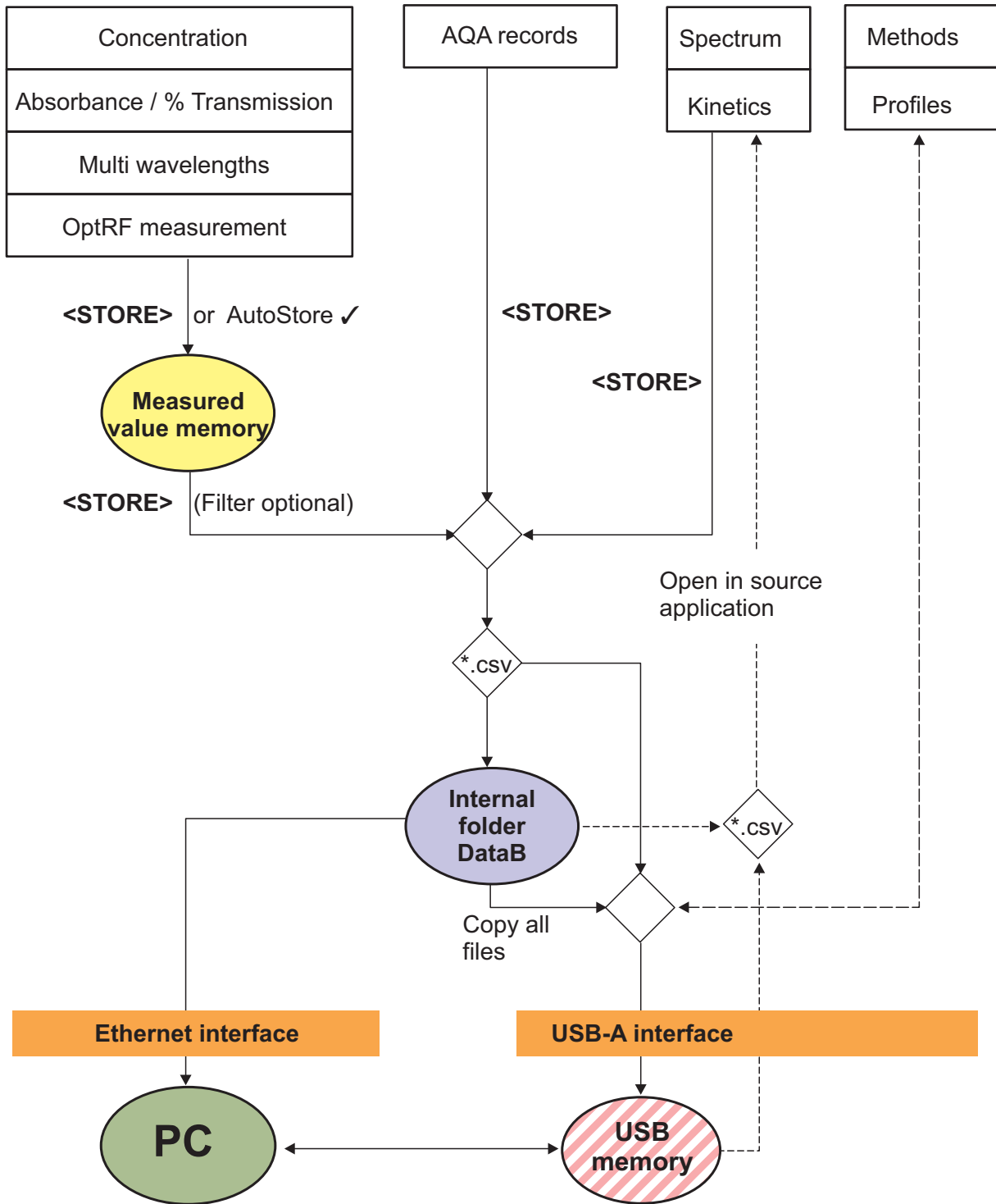

| Measured data | Save, back up, export |
|--|---|
| <p><i>Concentration,</i> <i>Absorbance / % Transmis-</i> <i>sion</i> <i>Special / Multi wavelengths</i> <i>OptRF measurement</i></p> | <p>Measurement datasets of these measuring modes are first stored in the measured value memory of the photometer (5000 memory locations) with <STORE> or <i>AutoStore</i>.</p> <p>The measured value memory is available from the <i>Measurement data memory</i> menu. Here you can view, filter and export into a PC-readable file (*.csv) the stored measurement datasets (<STORE>).</p> <p>Csv files of these measuring modes cannot be reimported to the photometer.</p> <p>Measurement datasets of these measuring modes can also be stored to a pdf file (see section 4.12.11).</p> |
| <p><i>Spectrum</i> <i>Kinetics</i></p> | <p>You can store and export measurement data of these measuring modes directly as a PC-readable file (*.csv) with <STORE>.</p> <p>Csv files of these measuring modes can be reimported and displayed on the photometer.</p> <p>Measurement data of these measuring modes can also be stored to a pdf file (see section 4.12.11).</p> |
| <p>AQA records</p> | <p>You can store and export measurement data of these measuring modes directly as a PC-readable file (*.csv) with <STORE>.</p> <p>Csv files of records cannot be reimported to the photometer.</p> <p>Measurement data of these measuring modes can also be stored to a pdf file (see section 4.12.11).</p> |
| <p>User-defined methods / profiles</p> | <p>Method data and profile data are stored and exported with the <i>Exchange methods/profiles</i> function in the <HOME>/General setup menu.</p> |

For each export procedure you can select the location where the PC-readable files (*.csv, *.pdf) should be stored: either to the photometer (*Internal DataB folder*) or an external memory (*USB memory*). On an external memory, the data are stored in the directory "DataB photoLab 7....".

The files stored in the photometer (*Internal DataB folder*) can later be transferred to a connected PC or to an external memory (*USB memory*).

4.12.2 Instructions on using USB memory devices

The safety of data stored on USB memory devices depends on the quality of the memory device and the data transmission.

Data is stored partly or not at all if for example:

- The power supply of the external memory device is interrupted during the write process, or
- The external memory device is prematurely disconnected from the photometer during the data backup.

To prevent a data loss we recommend the following:

- Save all data internally in the photometer first.
- After performing a backup leave the USB memory device connected to the photometer for some time.
- Check whether the stored data is complete, e.g. on a PC.
- Use the USB memory device for data transport but not for permanent data storage.

4.12.3 Measurement datasets

Elements of a measurement dataset

A complete measurement dataset consists of:

- Consecutive number (is automatically assigned by the photometer)
- Date/time
- Identification (e.g. ID or "AutoStore")
- User name
- Measured parameter, e.g. method number, dilution, wavelength (depending on the measuring mode)
- Measured value with unit and, if necessary, citation form

Operations with measurement datasets

Measurement datasets can be

- stored (see section 4.12.4)
- displayed and printed (see section 4.12.6)
- filtered, i.e. selected or hidden based on certain criteria (see section 4.12.7 and section 4.12.8)
- deleted (see section 4.12.9).

If the memory is full

You can erase measurement datasets (see section 4.12.9), or overwrite the oldest dataset with the next storing procedure. A security prompt appears before a dataset is overwritten. To backup the measurement data, you can transmit the measurement datasets from the measurement data memory to the internal DataB folder or a USB memory device connected to the USB-A connection and archive them further from there (see section 4.15).

4.12.4 Saving measurement datasets manually

After each measurement, you can store the measurement data manually with the **<STORE>** key. It is stored in the measurement data memory. The memory symbol  in the header indicates that the measurement data displayed on the screen is ready to be stored. With the measuring modes, *Concentration*, *Absorbance / % Transmission*, *Special / Multi wavelengths* and *OptRF*, you have the additional option to automatically store all new measured values at the time of the measurement (*AutoStore*, see section 4.12.5).

Storing with identification (ID)

When storing manually, an input field for the identification (ID) appears after pressing the **<STORE>** key. Here you can enter an individual combination of alphanumeric characters for later easier identification of the measurement datasets. 30 digits are available for this.

The following measurement data are stored in the measured value memory automatically (see section 4.12.5) or manually (with the **<STORE>** key, see section 4.12.4):

- Concentration
- Multi wavelength
- OptRF measurement
- Absorbance / % Transmission

The data stored in the measured value memory can be filtered with filter criteria and then exported to the PC-readable *.csv format.

The photometer automatically offers a file name during the storage procedure.

Example: Saving data from the measured value memory

```
<HOME>
Concentration,
Absorbance / % Transmission,
Special / Multi wavelengths or
OptRF measurement
├─ [Setup]
├─ Measurement data
```

1 If necessary, set the filter criteria with *[Setup]*.

2 Open the save dialog with **<STORE>**.

The photometer automatically proposes the location *Internal DataB folder* and a file name.

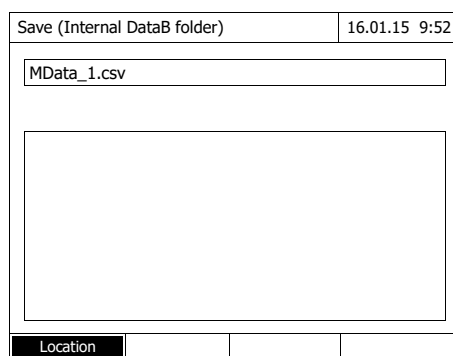

3 If necessary, change the location with *[Location]* (*USB memory*).

4 If necessary, change the proposed file name.

5 Save the measurement data with **<START·ENTER>**.

The data are stored.

If the photometer (*Internal DataB folder*) is selected as the location, the data can then be copied to a USB memory device (see section 4.15.1).

4.12.5 Saving measurement datasets automatically

For the measuring modes, *Concentration*, *Absorbance / % Transmission*, *Special / Multi wavelengths* and *OptRF*, you can record every measured value automatically (*AutoStore*). The *AutoStore* function is active in the default condition.

All automatically stored measurement datasets are given the ID "AutoStore". The "AutoStore" ID is overwritten if the same measured value is manually stored afterwards (**<STORE>**).

This ensures that every measurement dataset is stored in the data memory only once.

Activating or deactivating the *AutoStore* function

Activate or deactivate the *AutoStore* function as follows:

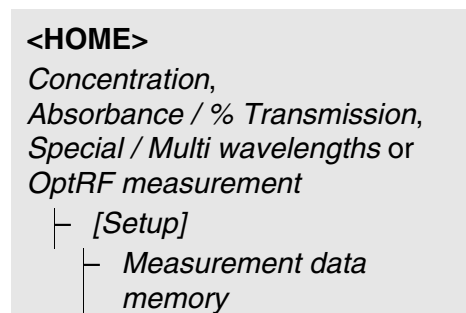

The available functions are displayed.

- 1 Select and confirm *AutoStore*.
The *AutoStore* function is active (✓) or inactive (no checkmark).
- 2 If required, give the automatically stored measured values and ID with the menu item *AutoStoreID*.
- 3 If the menu item *Increment AutoStoreID* is selected (✓), the ID of the automatically stored measured values is given a consecutive number.



The *AutoStore* setting applies to the measuring modes *Concentration*, *Absorbance / % Transmission*, *Special / Multi wavelengths* and *OptRF measurement* in general.

4.12.6 Displaying measurement data memory

Depending on the operating situation, you can recall the measured value memory as follows:

From the main menu

```
<HOME>
[Setup],
├─ Measurement data memory
```

From a measuring mode

```
Concentration,
Absorbance / % Transmission,
Special / Multi wavelengths or
OptRF measurement
├─ [Setup]
├─ Measurement data
memory
```

Each of these options indicates the contents of the measurement data mem-

ory as a list as follows.

| Measurement data memory | | | | 16.01.15 | 9:52 |
|-------------------------|-------|--------------|---------------|-----------|------|
| 15.01.15 | 14:00 | 3.50 mg/l Ni | Administrator | AutoStore | |
| 15.01.15 | 14:05 | 3.64 mg/l Ni | Administrator | AutoStore | |
| 15.01.15 | 14:10 | 3.69 mg/l Ni | Administrator | AutoStore | |
| 15.01.15 | 14:15 | 3.72 mg/l Ni | Administrator | AutoStore | |
| 15.01.15 | 14:20 | 3.72 mg/l Ni | Administrator | AutoStore | |
| 15.01.15 | 14:25 | 3.75 mg/l Ni | Administrator | AutoStore | |
| 15.01.15 | 14:30 | 3.73 mg/l Ni | Administrator | AutoStore | |
| 15.01.15 | 14:35 | 3.80 mg/l Ni | Administrator | AutoStore | |
| 15.01.15 | 14:40 | 3.78 mg/l Ni | Administrator | AutoStore | |
| Filter ✓ | | | | | |
| Memory space usage: 9/ | | | | | |
| Setup | | Single value | | Delete | |

If there are more datasets available than can be displayed, the arrows ▲ and ▼ are displayed additionally.

Filter ✓ indicates that the filter settings are active. In this case, only those datasets are displayed that correspond to the selected filter criteria (see section 4.12.7).

Options

Measurement datasets can be

- displayed in short form as a list or in details as individual values ([List] <--> [Single value])
- filtered (see section 4.12.7 and section 4.12.8)
- deleted (see section 4.12.9).
- with <STORE>, you can store the entire displayed list as a *.csv file in the internal DataB folder or on a USB memory device connected to the USB-A connection. The filter settings apply to the storing process. You can freely select the file name. Thus you can, e. g. store in a separate file and systematically archive measurement data of a certain period.
- with <PRINT>, the entire displayed list can be printed. The filter settings apply to the print process.

4.12.7 Filtering measurement datasets

The functions to display, delete and download stored measurement datasets refer to all stored measurement datasets that correspond to the specified filter criteria.

Filter criteria

The following filter criteria can be set:

- *Mode* (measured parameter)
- *User*
- *ID* (identification)
- *Date* (date from ... to ...)
- *Method* (for the measured parameters, *Concentration* and *Multi wavelength*)

<HOME>

Concentration,
Absorbance / % Transmission,
Special / Multi wavelengths or
OptRF measurement

- ├ [Setup]
 - ├ Measurement data memory
 - └ Setup

Filter

- ├ Mode (Concentration, etc.)
- ├ User (<A...9>)
- ├ ID (<A...9>)
- ├ Date (from ... to ...)
- └ Method

The filter setting menu is displayed.

- 1 Set the filter criteria.
- 2 If necessary, deactivate any selected filter criteria with *[Reset entry]*.
- 3 Confirm the filter selection with *[Apply]*.

| Measurement data memory | | | | 16.01.15 9:52 |
|-------------------------|--------------|---------------|-----------|---------------|
| 15.01.15 14:00 | 3.50 mg/l Ni | Administrator | AutoStore | |
| 15.01.15 14:05 | 3.64 mg/l Ni | Administrator | AutoStore | |
| 15.01.15 14:10 | 3.69 mg/l Ni | Administrator | AutoStore | |
| 15.01.15 14:15 | 3.72 mg/l Ni | Administrator | AutoStore | |
| 15.01.15 14:20 | 3.72 mg/l Ni | Administrator | AutoStore | |
| 15.01.15 14:25 | 3.75 mg/l Ni | Administrator | AutoStore | |
| 15.01.15 14:30 | 3.73 mg/l Ni | Administrator | AutoStore | |
| 15.01.15 14:35 | 3.80 mg/l Ni | Administrator | AutoStore | |
| 15.01.15 14:40 | 3.78 mg/l Ni | Administrator | AutoStore | |

Filter ✓
Memory space usage: 9/

Setup | Single value | Delete

The *Measurement data memory* list is displayed.

The following information is displayed additionally:

- Current memory occupancy
- Active filter criteria (*Filter* ✓)



Alternatively, you can hide measurement datasets that meet the specified filter criteria with the *Selected values: invert selection* function (see section 4.12.8).

4.12.8 Inverting filters

With the *Selected values: invert selection* function you can hide all measurement datasets that correspond to the specified criteria of the filter (see section 4.12.7).



You can use this function to select and delete measurement datasets no longer used.

<HOME>
*Concentration,
 Absorbance / % Transmission,
 Special / Multi wavelengths or
 OptRF measurement*

- | [Setup]
- | | Measurement data memory
- | | Setup

| Measurement data memory | | | 16.01.15 9:52 | |
|-------------------------|-------|--------------|---------------|-----------|
| 15.01.15 | 14:00 | 3.50 mg/l Ni | Administrator | AutoStore |
| 15.01.15 | 14:05 | 3.64 mg/l Ni | Administrator | AutoStore |
| 15.01.15 | 14:10 | 3.69 mg/l Ni | Administrator | AutoStore |
| 15.01.15 | 14:15 | 3.72 mg/l Ni | Administrator | AutoStore |
| 15.01.15 | 14:20 | 3.72 mg/l Ni | Administrator | AutoStore |
| 15.01.15 | 14:25 | 3.75 mg/l Ni | Administrator | AutoStore |
| 15.01.15 | 14:30 | 3.73 mg/l Ni | Administrator | AutoStore |
| 15.01.15 | 14:35 | 3.80 mg/l Ni | Administrator | AutoStore |
| 15.01.15 | 14:40 | 3.78 mg/l Ni | Administrator | AutoStore |

Filter ✓
 Memory space usage: 9/

| | | |
|-------|--------------|--------|
| Setup | Single value | Delete |
|-------|--------------|--------|

The *Measurement data memory* list is displayed. All measurement datasets corresponding to the filter criteria are hidden.

4.12.9 Erasing stored measurement datasets

If you no longer need any stored measurement datasets, you can erase them individually or altogether.

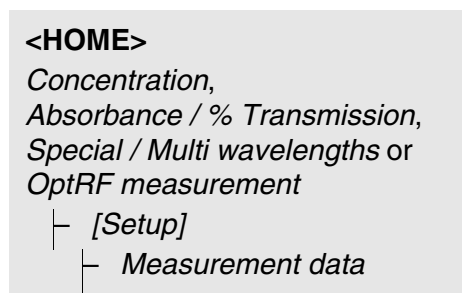

| Measurement data memory | | | 16.01.15 9:52 | |
|-------------------------|--------------|---------------|---------------|--|
| 15.01.15 14:00 | 3.50 mg/l Ni | Administrator | AutoStore | |
| 15.01.15 14:05 | 3.64 mg/l Ni | Administrator | AutoStore | |
| 15.01.15 14:10 | 3.69 mg/l Ni | Administrator | AutoStore | |
| 15.01.15 14:15 | 3.72 mg/l Ni | Administrator | AutoStore | |
| 15.01.15 14:20 | 3.72 mg/l Ni | Administrator | AutoStore | |
| 15.01.15 14:25 | 3.75 mg/l Ni | Administrator | AutoStore | |
| 15.01.15 14:30 | 3.73 mg/l Ni | Administrator | AutoStore | |
| 15.01.15 14:35 | 3.80 mg/l Ni | Administrator | AutoStore | |
| 15.01.15 14:40 | 3.78 mg/l Ni | Administrator | AutoStore | |

Filter ✓
Memory space usage: 9/
Setup Single value Delete

The *Measurement data memory* list is displayed.

The filter settings used last are active.

Erasure functions

The following erasure functions are available.

- Erasing an individual measurement dataset
 - 1 Highlight a measurement dataset.
 - 2 Remove the highlighted measurement dataset with *[Delete]*.
- Erasing all measurement datasets of the displayed list
 - 1 Open the setting menu with *[Setup]*.
 - 2 Select and confirm *Delete memory (selected values only)*.
All measurement datasets corresponding to the current filter criteria are erased.
or
Select and confirm *Delete memory (all values)*.
All measurement datasets are erased.
- Erasing all measurement datasets
 - 1 Highlight a measurement dataset.
 - 2 Remove the highlighted measurement dataset with *[Delete]*.

4.12.10 Saving kinetic recordings, spectra and AQA files

After the following measurements, the *Save* dialog opens and prompts you to save the data in a *.csv file:

- *Kinetics*
- *Spectrum*
- *AQA3/MatrixCheck*

If the data are not saved in *.csv format, they are lost when the measuring mode is terminated.



During a kinetic recording, the current measurement is always saved in the file, "KineticsBackup.csv" for safety reasons.

4.12.11 Saving data as a pdf file

All data that can be printed (printer symbol on the display) can also be saved as a pdf file. The pdf file contains the data that are also output to a USB printer. Kinetic recordings and spectra are stored in the pdf file as a graphic.

Saving as a pdf file and printing is done with the **<PRINT>** key. Prerequisite is that pdf printing is set as the printer in the menu **<HOME>/General setup/Data transfer/Printer/Function of PRINT key**.

Subsequently, enter a file name and select the storage location (internally folder DataB or USB memory device).

4.13 Ethernet interface

The connection between the photometer and PC is made via an Ethernet network connection. The connection can be made in the following ways:

- Connection of photometer and PC to the same network (e.g. photometer via Ethernet cable [LAN], PC via Ethernet cable [LAN] or wireless [WLAN])
- Direct connection of photometer and PC

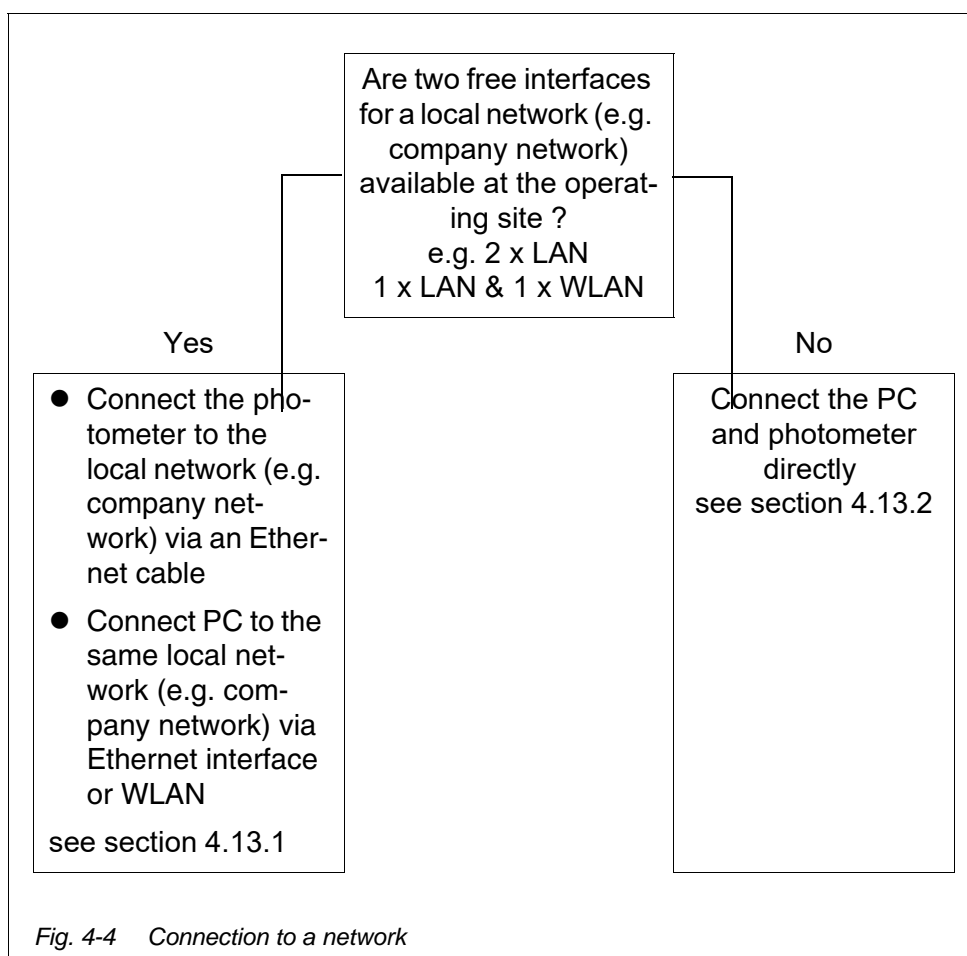

4.13.1 Integrating the photometer into an existing network (e.g. company network)

Prerequisite

A local network (e.g. company network) with network interfaces (Ethernet interface [LAN] / wireless access [WLAN]) for photometer and PC is available at the operating site of the photometer.



Please note:
Approval from the network administrator may be required to integrate a device into a company network.

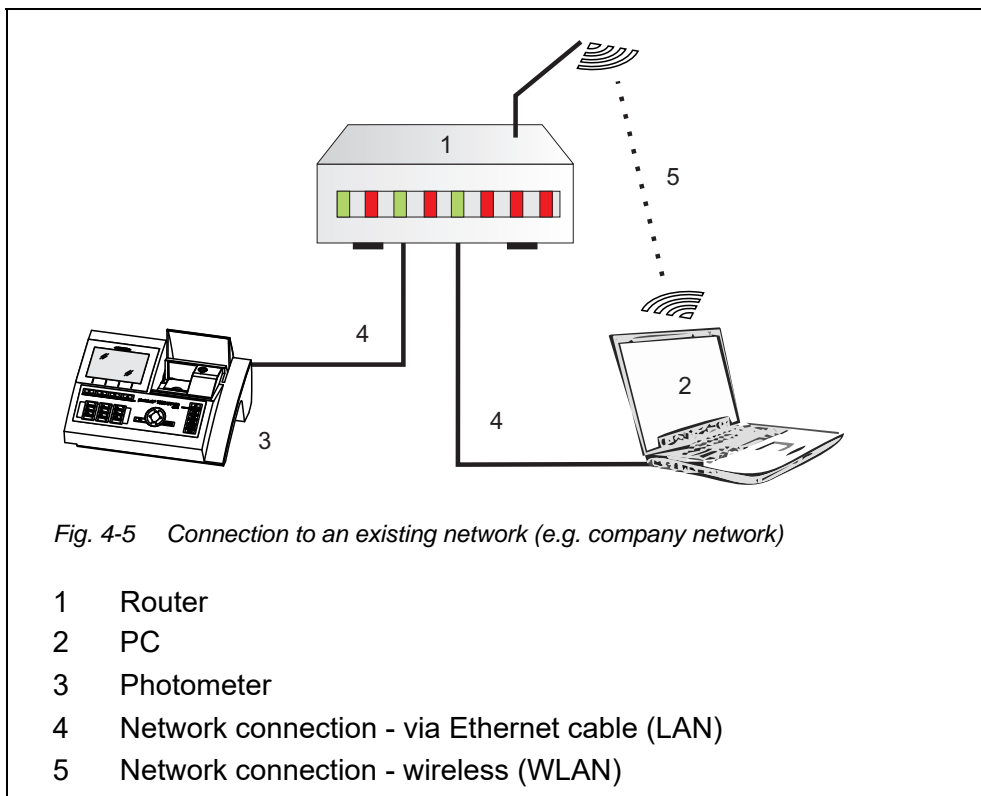

- 1 Use an Ethernet cable to connect the Ethernet interface of the photometer to the Ethernet interface of the existing network (e.g. company network).
- 2 Switch on the photometer

Settings at the photometer

```
<HOME>
[Setup]
| Ethernet
```

- 1 Open the *Ethernet* menu (<HOME> / [General setup] / Ethernet).

| | |
|------------|----------------|
| Ethernet | 19.01.17 13:52 |
| DHCP | Ja |
| IP-Adresse | 192.168.10.2 |
| Subnetmask | 255.255.255.0 |
| Abbrechen | Übernehmen |

2 For the *DHCP* setting: Select *Yes*.

```
<HOME>
[Setup]
├ Ethernet
```

3 Confirm the setting with *[Apply]*.

4 Open the *Ethernet* menu (**<HOME>** / *[General setup]* / *Ethernet*).

The IP address assigned by the network server is displayed.

5 Note the IP address of the photometer in the network.

This IP address must be entered in the photoLab® Data *spectral* software to establish the connection.

6 Quit the menu with *Cancel*.



Data transfer with photoLab® Data *spectral* (see section 4.14).

Save data with FTP connection (see section 4.15.3)

4.13.2 Connecting the photometer directly to the PC

If no access to an existing network is available for the photometer, only a direct connection to a PC is possible.

Depending on the available number of Ethernet interfaces, the connection to the PC is made in one of the following ways.

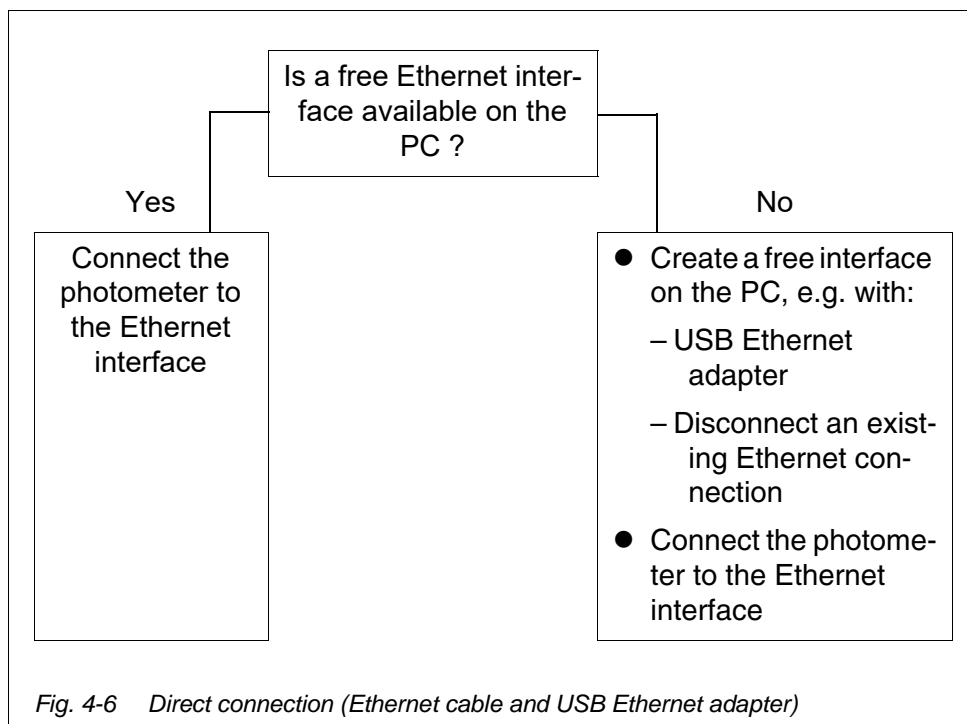

When unplugging an existing Ethernet connection, some functions are no longer available (e.g. email program, chat program, access to network drives, etc.).

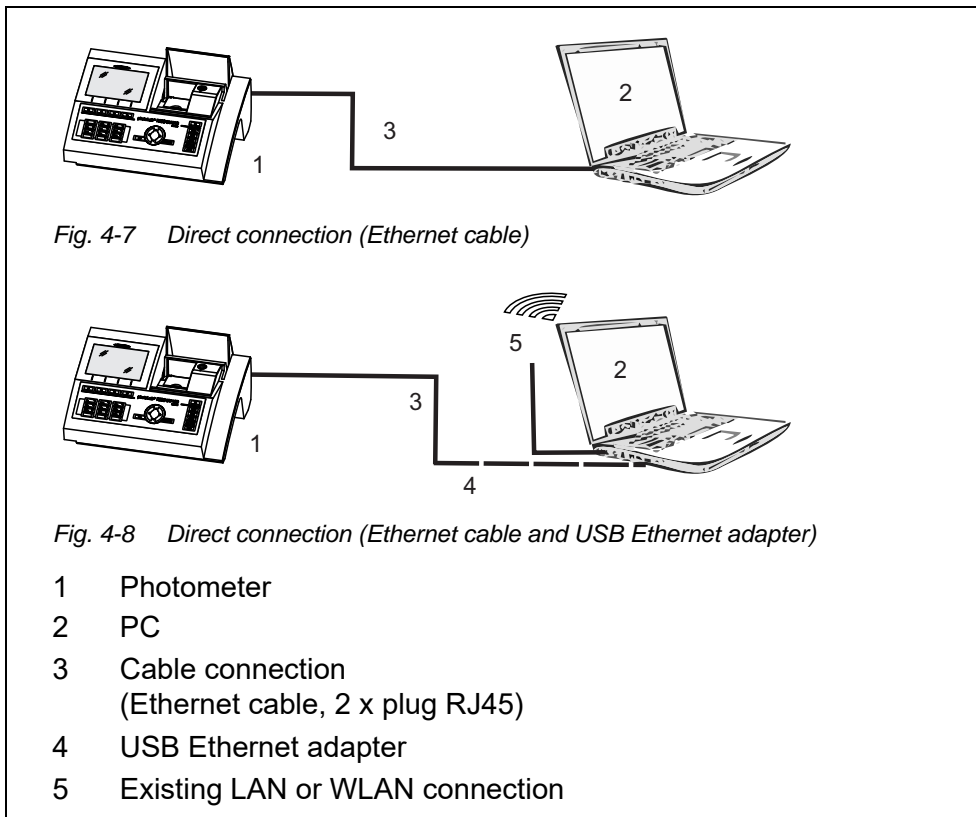

A new Ethernet network is created on the PC via a USB Ethernet adapter. This allows the PC to be part of a company network and manage a connection to a second Ethernet network at the same time, for example.

Prerequisite

- The photometer and PC are switched on
- The photometer and PC are connected with an Ethernet cable
- When connecting via USB Ethernet adapter:
 - A USB Ethernet adapter is connected to the PC
 - The photometer and PC are connected via Ethernet cable and USB-Ethernet adapter

Settings at the photometer

```
<HOME>
[Setup]
| Ethernet
```

- 1 Open the Ethernet menu (<HOME> / [Settings] / Ethernet).

| | |
|------------|----------------|
| Ethernet | 19.01.17 13:52 |
| DHCP | Nein |
| IP-Adresse | 192.168.10.2 |
| Subnetmask | 255.255.255.0 |
| Abbrechen | |
| Übernehmen | |

When the photometer and PC are connected for the first time, the factory settings for the Ethernet connection are active.

DHCP: No

IP-Adresse: 192.168.10.2

Subnetmask: 255.255.255.0



Use these settings for the configuration of the Ethernet on the PC. The IP address of the PC must differ in the last digit. Recommendation: 192.168.10.1

Settings on the PC

- 1 Display all available network connections on the PC (e.g. Windows search: "Show network connections").
- 2 Open the "Properties" window for the Ethernet.
With USB Ethernet adapter:
Open the "Properties" window for the USB Ethernet adapter.
- 3 Open the Internet Protocol (TCP/IPv4) Properties window.
- 4 In the "General" tab, enter the fixed IP address for the PC.
The IP address must differ in the last digit from the IP address of the photometer.
When using the factory setting on the photometer, e.g. "192.168.10.1"
- 5 In the "General" tab, enter the subnet mask (recommended: "255.255.255.0").
- 6 Confirm the configuration.



Data transfer with photoLab® Data *spectral* (see section 4.14).

Save data with FTP connection (see section 4.15.3)

4.14 Data transfer (PC software photoLab® Data *spectral*)

The photoLab® Data *spectral* software allows direct data exchange between the photometer and PC.

Prerequisites

- Existing connection of photometer and PC via Ethernet network (see section 4.13 ETHERNET INTERFACE).
- Software photoLab® Data *spectral* installed on the PC (see operating manual photoLab® Data *spectral*)

- 1 Start the photoLab® Data *spectral* software.
- 2 Enter the IP address of the photometer in the login window

For details on installation and data exchange, see operating manual photoLab® Data *spectral*

4.15 Backup or export data

You can copy from the photometer to a PC the following data:

- Measured data
- Spectra
- Kinetic recordings
- AQA records
- User-defined methods
- Profiles

After saving measurement data in *.csv or *.pdf format, you can copy them to a PC. Measurement data in csv format can be directly imported to and processed in spreadsheets such as Microsoft® Excel®.



Depending on the country variant, some spreadsheet programs require a certain decimal separator for the correct import of numerical values (comma or point). The decimal separator can be selected in the following menu:

<HOME> -> *General setup* -> *Data transfer/Printer* -> *Decimal separator for csv-Files*.

Files containing measurement data can be copied to a PC in the following ways:

- USB interface

By using a USB memory device as a temporary storage (see section and section 4.15.1). Subsequently, you can connect the USB memory device to a PC and read out the data.

- Ethernet interface
 - via the program photoLab® Data *spectral* (see section 4.14 DATA TRANSFER (PC SOFTWARE PHOTOLAB® DATA SPECTRAL)).
 - Via an FTP connection (see section 4.15.3 ACCESSING PHOTOMETER FILES VIA A FTP CONNECTION)



Please follow the instructions on using USB memory devices (see section 4.12.2).

4.15.1 Copying all measurement data files to a USB memory device

Even if no PC is directly connected to the photometer, you can very simply transfer all measurement data files from the photometer (*Internal DataB folder*) to a connected USB memory device.





```
<HOME>
[Setup]
| Save data to USB memory
| device
```

When the data saving procedure is finished, a message appears.

- 1 Confirm the message with **<STORE>**.

All measurement data files from the photometer (*Internal DataB folder*) have been transferred to the USB memory device.

The complete folder structure from the photometer is created on the USB memory device. The individual measurement data files are stored in subfolders sorted by measurement data types:

| Name | Änderungsdatum |
|---|------------------|
|  CurrentMeasureDataStorage | 18.01.2017 15:43 |
|  Kinetics | 18.01.2017 15:43 |
|  MeasuredDataStorage | 18.01.2017 15:43 |
|  OptRFSpectras | 18.01.2017 15:43 |
|  Spectrum | 18.01.2017 15:43 |

4.15.2 Copying user-defined methods / profiles to a USB memory device

<HOME>
[Setup]
— Exchange methods/profiles
/ Store to USB memory
device

A list is displayed that includes all user-defined methods and profiles available on the photometer. All methods and profiles are checked off with a checkmark. All methods and profiles checked off are saved.

- 1 If necessary, select individual methods/profiles with <▲ ><▼ > and remove the checkmark with <START·ENTER>.

These methods/profiles will not be saved.

- 2 Start the save process with *[Store]*.

A message appears when the data have been saved.

- 3 Confirm the message with <START·ENTER>.

The save process is completed. The data are stored in the *Exchange_Method_Profile* folder on the USB memory device. The individual files with the methods/profiles are in subfolders.

Already existing files with identical names are overwritten without confirmation prompt.

4.15.3 Accessing photometer files via a FTP connection

You have access to the photometer via FTP (read access only). You can e.g. copy the files stored on the photometer to a PC.

Prerequisite

There is an Ethernet connection between the photometer and PC (see section 4.13 ETHERNET INTERFACE).

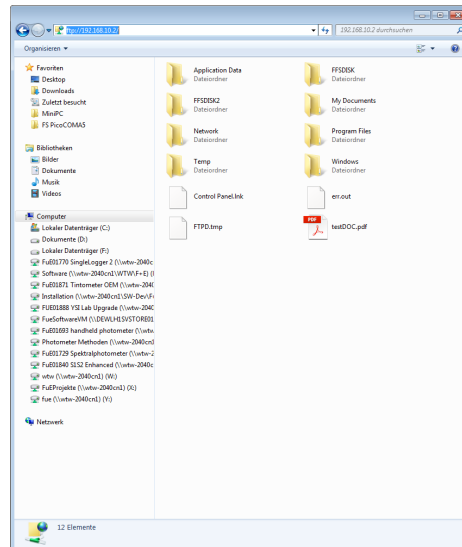

Enter ftp://IP-address in the Windows Explorer on the PC. The folders stored on the photometer are displayed.

The FFSDISK folder contains the relevant photometer data in the following sub-folders:

FFSDISK\DataB:

General measured values, kinetics, spectra, records, OptRF measured values.

FFSDISK\UserMethods:

User-defined methods (concentration)

FFSDISK\MWLMETHODS :

Special / Multi-wavelengths methods

FFSDISK\KineticProfiles:

Kinetic profiles

4.16 Importing files

You can import to a pFotoLab® 7xxx spectrophotometer the data that were created with the same or another pFotoLab® 7xxx spectrophotometer, and were then saved to a USB memory device or a PC.

You can import the following data:

- Spectra
- Kinetic recordings
- User-defined methods
- Profiles

4.16.1 Importing spectra or kinetic recordings from a USB memory device

You can import to the photometer any spectrum or kinetic recording by opening an externally stored spectrum or kinetic recording with the Open function of the photometer.

4.16.2 Importing methods / profiles from a USB memory device



When importing methods make sure that your photometer supports the wavelengths of the imported methods.

```
<HOME>
[Setup]
├ Exchange methods/profiles
  / Import from USB memory
  device
```

A list is displayed including all user-defined methods and profiles stored in the corresponding sub-folders of the Exchange directory on the USB memory device. All methods and profiles are checked off with a checkmark. All methods and profiles checked off are imported.

- 1 If necessary, select individual methods/profiles with <▲ ><▼ > and remove the checkmark with <START·ENTER>.

These methods / profiles are excluded from importing.

- 2 Start the import with [*Import*].

A confirmation prompt appears before any data on the photometer are overwritten.

A message appears when the data have been imported.

- 3 Confirm the message with <START·ENTER>.

The import is completed. The imported methods / profiles are available on the photometer.

4.16.3 Importing files from a PC

Via the photoLab® Data *spectral* program, you can import data from the PC to the photometer (see operating manual of the program photoLab® Data *spectral*).

4.17 Printing the data (USB)

4.17.1 Printer and terminal programs

Usable printers

Data can be printed with standard printers (ink-jet or laser) at the USB-A interface. Suitable are the following PCL compatible printers.

- PCL 3, PCL 3 Enhanced
- PCL 5, PCL 5c, PCL 5e
- PCL 6 Standard

Unsuitable are printers using the following printer languages:

- PCL 3 GUI, PCL 6 Enhanced, PCL XL

The printer symbol  indicates that the display contents can be printed. To print, press **<PRINT>**.

pdf file

As an alternative, you can also output the print data to a pdf file.



In den following paragraphs, "Print" means:

- output to a USB printer
- output to a pdf file.

4.17.2 Settings for data transmission

Settings are possible for the data transmission to a printer or PC.

Decimal separators for CSV files

For the output of CSV files you can select either a comma or a point as the decimal separator. The setting is made in the following menu:

<HOME> -> *General setup* -> *Data transfer/Printer* -> *Decimal separator for csv-Files* -> *Comma (12,34)* or *Point (12.34)*.

Short and long version

When printing measurement datasets, you can select a short or long version with different information contents. The setting is made in the following menu:

<HOME> -> *General setup* -> *Data transfer/Printer* -> *Data format (print)* -> *Short* or *Extended*.

Printer

Here you can set which function is assigned to the **<PRINT>** key:

- Output to a USB printer
- Output as pdf file

The setting is made in the following menu:

<HOME> -> *General setup* -> *Data transfer/Printer* -> *Function of PRINT key* -> *USB printer* or *PDF file*.

4.17.3 Printing measurement datasets

This section describes how to print measurement datasets of the measuring modes, *Concentration*, *Absorbance / % Transmission*, and *Special / Multi wavelengths*.

By means of sample printouts, the printed information is described below:

Concentration and Special / Multi wavelengths mode

```
21 05.06.07 14:05:41 C4/25 844 mg/l COD      Inlet
Administrator 0.005 02.06.07 11:02:13 2 AQA1: 9 AQA2: 14
```

Structure of the lines from left to right:

1st line:

*[Consecutive no.] [Date] [Time] [Method name] [Measured value] [Unit]
[Citation form] [Dilution] [ID or "AutoStore"]*

2nd line (long version only):

*[User] [Reagent blank value] [Date of blank value measurement]
[Time of blank value measurement] [Lot ID of blank value measurement]
[AQA1: label] [AQA1: record no.] [AQA2: label] [AQA2: record no]*



Optional elements (e.g. dilution or ID) are output only if they were really used for measurement or storage.

Mode Absorbance / % Transmission

```
14 05.06.07 11:25:01 445 nm 0.609 Absorbance AutoStore
Administrator 0.133 02.06.07 09:59:01 AQA1: 9
```

Structure of the lines from left to right:

1st line:

*[Consecutive no.] [Date] [Time] [Wavelength] [Measured value]
["Absorbance" or "Transmission" mode] [ID or "AutoStore"]*

2nd line (long version only):

*[User] [Value of reference absorbance] [Date of reference absorbance] [Time
of reference absorbance] [AQA1: label] [AQA1: record no.]*



Optional elements (e.g. ID or reference absorbance) are output only if they were really used for measurement or storage.

4.17.4 Printing spectra or Kinetics records



If you output a spectrum or kinetic record to a USB printer or as a pdf file, the current graphic display is shown on the display.

4.18 Analytical quality assurance (AQA)

4.18.1 General information

The target of the analytical quality assurance (AQA) is to secure correct and precise measurement results.



Settings for AQA checks are only available for users of the user group, administrator.

Every registered user can carry out the AQA check (see also section 4.19.1).

Analytical quality assurance (AQA) can be carried out in two steps independent of each other:

- AQA1: Monitoring of the photometer
- AQA2: Monitoring of the total system.
It comprises the photometer, the used test, the accessories and the user's way of working.

The monitoring includes a check procedure that has to be successfully repeated by the user within a certain period (AQA interval).



The AQA monitoring is not active in the delivery condition.

AQA in measured value documentation

All values that are measured after a passed check and within the AQA interval are given the addition *Protocol ID* in the measured value documentation. This addition is used to identify the relevant AQA inspection record.

4.18.2 Photometer monitoring (AQA1)

At least one set of test standards such as Spectroquant® PhotoCheck, CertiPUR® or other commercial test equipment (e.g. filter) is required for the photometer monitoring.

The administrator specifies which test standard has to be used as the minimum requirement for the AQA1 monitoring.

The extent of the monitoring can be enlarged with further test standards.



Settings for AQA checks are only available for users of the user group, administrator.

Every registered user can carry out the AQA check (see also section 4.19.1).

Spectroquant® PhotoCheck

The PhotoCheck consists of 12 test standards in duplicate, 2 zero cells and 2 cells to check the barcode reader. Each PhotoCheck package contains a lot dependent test certificate with all nominal values (absorbances) and tolerances of the test standards. These values are entered in the photometer during the configuration of the AQA1 check.

CertiPUR® test standards

Each CertiPUR® standard is provided with a lot dependent test certificate with all nominal values (absorbances) and tolerances of the test standards. The values were preset in the factory.



Observe the shelf life of the test standards. The values in the photometer always have to be checked when a new package of test standard is used. If necessary, adjust the values at the photometer.

Overview of the photometer monitoring

Photometer monitoring (AQA1) consists of the following parts:

- Configuring settings in the *AQA1 setup* menu.
 - Activate AQA1
 - Specify AQA1 Interval
 - Activate/deactivate the meter lock for missing or expired AQA1 check
 - Define the extent of the AQA1 monitoring by activating or deactivating the individual test standards.
 - Enter the nominal values, tolerances and lot numbers for the individual test standards
- Carrying out the AQA1 check. The photometer compares the results with the nominal values while taking into account the tolerances.

The steps are described in detail below.

Activating AQA1

The AQA1 monitoring is activated in the *Mode* menu:

```
<HOME>
[AQA]
├─ AQA1 setup
└─ Mode
```

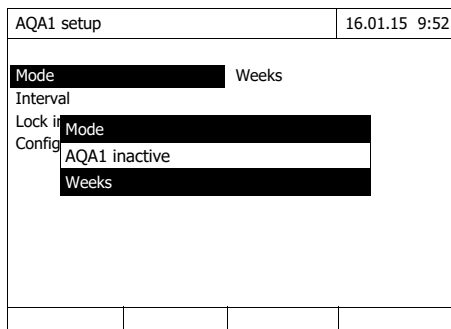

Select and confirm *Weeks*.
 AQA1 is active.
 The *Interval* setting indicates *Weeks* as the interval unit.

Defining the AQA1 Interval

The AQA1 Interval defines the interval between two AQA1 checks. When an interval has expired, the following consequences become effective:

- Warning and loss of the AQA1 labeling
- Locking of the photometer against all measurements (if activated).

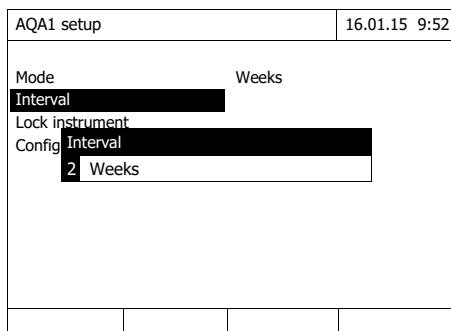
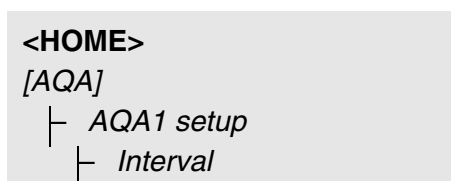

- 1 Enter a numeric value (2 to 52 weeks) (<0...9>) and confirm
 The *Interval* defined for the AQA1 check is active.

Configuring the lock of the photometer

Here you configure whether or not the photometer will be locked against all measurements if there is no valid AQA1 check or the interval for the AQA1 check has expired.

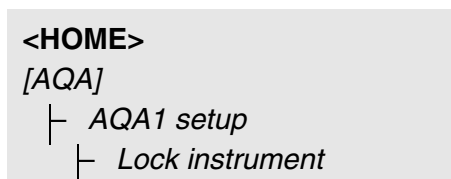

| | |
|-----------------|---|
| AQA1 setup | 16.01.15 9:52 |
| Mode | Weeks |
| Interval | |
| Lock instrument | |
| Config | Should the instrument be locked for further measurements if AQA1 check is invalid or has expired? |
| | No |
| | Yes |

1 Select and confirm Yes.

The photometer is locked against all measurements if the AQA1 check is invalid or the AQA1 interval has expired.

Configuration of tests ...

```

<HOME>
[AQA]
├─ AQA1 setup
└─ Configuration of tests ...
    
```

| | |
|--------------------|-------------------|
| AQA1 setup | 16.01.15 9:52 |
| PhotoCheck | Active |
| CertiPUR UV-VIS 1 | Inactive |
| CertiPUR UV-VIS 1A | Inactive |
| CertiP | CertiPUR UV-VIS 1 |
| CertiP | General setup |
| CertiP | Activate |
| | Apply |

All possible test standards or test standard sets are listed.

- 1 Select and confirm a test standard or test standard set.
- 2 Adjust and confirm the extent of the monitoring with *Activate* or *Deactivate*.
- 3 Confirm the test standard (set) once again.
- 4 Switch to the adjustment of the nominal values and tolerances with *Setup*.

| | | |
|-------------|---------------|-----------|
| PhotoCheck | 16.01.15 9:52 | |
| Lot number: | HC616115 | |
| Use by | 16.04.2008 | |
| | Target value | Tolerance |
| 445/1 | 0.196 | ± 0.020 |
| 445/2 | 0.500 | ± 0.030 |
| 445/3 | 0.998 | ± 0.040 |
| 445/4 | 1.508 | ± 0.050 |
| 525/1 | 0.197 | ± 0.020 |
| 525/2 | 0.495 | ± 0.030 |
| 525/3 | 0.992 | ± 0.040 |
| 525/4 | 1.496 | ± 0.050 |
| | | Apply |

Example PhotoCheck:

- 5 Using <▲ ><▼ > and <<◀ >>▶ >, select the *Lot number*, *Target value* or *Tolerance* entries and open them for editing with <START·ENTER>.
- 6 Enter and confirm the required value (<0...9>)
- 7 Accept all values with [Apply].

Carrying out the AQA1 check (example: PhotoCheck)

The AQA1 check comprises the check with all test standards activated in the menu *AQA menu / AQA1 setup / Configuration of tests ...* for AQA1 (see page 141).

First, a zero adjustment for all wavelengths takes place. Subsequently, the first individual checks with the selected test standards take place (e.g. PhotoCheck).

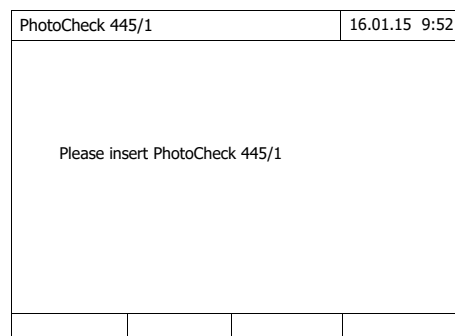
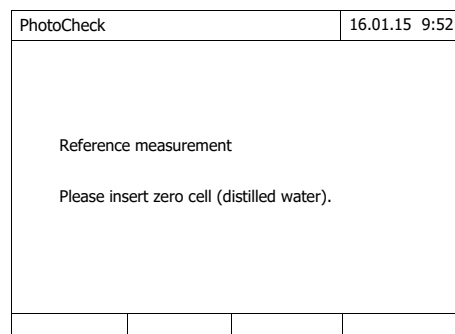
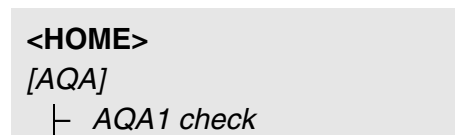

The photometer is ready for the zero adjustment.

- 1** Insert the zero cell. The cell is automatically recognized and the zero adjustment is started for all wavelengths.

After the successful zero adjustment, the photometer is ready to measure the PhotoCheck test standard 445/1.

- 2** Insert the cell. The cuvette is automatically recognized and the measurement started.

After measuring, the measurement result, Target value, Tolerance and an evaluation (OK or failed) are displayed.

The photometer offers to repeat the measurement if the check failed.

If the check was successful, the measurement of the next PhotoCheck test standard, e.g. 445/2, appears on the display.

- 3** Measure all test standards in the same way. After all test standards are successfully measured, the check is passed.

Test record

A test record is displayed after the check. It can be printed and stored as a file (in the internal DataB folder or USB memory device at the USB-A connec-

tion, see section 4.12.1).

Sample printout:

```

photoLab 7600 UV-VIS 09130512 1.30-WTW-1.60 Administrator
AQA1                OK
Protocol ID                9
Executed by:            Administrator
Executed                16.01.2015
Valid until:            16.02.2015

PhotoCheck            OC479094                OK
445-1                0.200 +- 100                0.192
445-2                0.500 +- 200                0.511
445-3                1.000 +- 200                1.006
445-4                1.500 +- 200                1.526
525-1                0.200 +- 200                0.247
.....
.....
.....
(etc.)

```



Afterwards you can view the last AQA1 test record under *AQA1 info*.

4.18.3 Total system monitoring (AQA2)

For the total system monitoring, standard solutions with a defined analyte content are required (preferably certified Spectroquant® CombiCheck standards).



Settings for AQA checks are only available for users of the user group, administrator.
The AQA check can be carried out by any registered user.

Spectroquant® CombiCheck

Spectroquant® CombiCheck standards are multiparameter standards ready to use, i. e. they can be used for several test sets (methods).

In addition to the CombiCheck standards, one parameter standard solutions can also be used. They are prepared by dilution to the respective end concentration. The end concentration should be in the middle of the measuring range.



The suitable CombiCheck standards and one parameter standards are listed in the WTW catalog or on the Internet.

Overview of the total system monitoring

Total system monitoring (AQA2) consists of the following parts:

- Configuring the general settings in the *AQA2 setup* menu.
 - Activate AQA2
 - Select the AQA2 interval unit (*Weeks* or *Measurements*)
 - Activate/deactivate the measurement lock for missing or expired AQA2 check. The measurement lock is effective for all methods that were activated for AQA2 monitoring
- Selecting the method to be activated for AQA2
- Configuring the method-specific settings in the *AQA2 setup* menu.
 - Activate AQA2
 - Specify AQA2 Interval
 - Enter the nominal value, tolerance and designation (standard ID) for the test standard
- Carrying out the AQA2 check. During the check the test is carried out with the standard solution as the sample while the other conditions are the same. The photometer compares the result with the nominal value while taking the tolerance into account.

The steps are described in detail below.

General AQA2 settings



| | | | |
|--------------|-------|---------------|--|
| AQA2 setup | | 16.01.15 9:52 | |
| Mode | Weeks | | |
| Lock methods | Yes | | |
| Method ... | | | |
| Method list | | | |

- 1 Select and confirm *Mode*.
The *Mode* selection field pops up.
- 2 Select and confirm *Weeks* or *Measurements*.

AQA2 is active. For all methods, the AQA2 intervals are entered either in weeks or number of measurements.
- 3 Accept the general settings with *[Apply]*.



When the mode (*Weeks* or *Measurements*) is changed, all AQA2 intervals are reset to the preset values.

Locking the method

Here you configure whether or not a method will be locked against measurement if there is no valid AQA2 check or the interval for the AQA2 check has expired.

```
<HOME>
[AQA]
├─ AQA2 setup
```

| AQA2 setup | | 16.01.15 9:52 | |
|--------------|-------|---------------|--|
| Mode | Weeks | | |
| Lock methods | Yes | | |
| Method ... | | | |
| Method list | | | |

- 1 Select and confirm *Lock methods*.
- 2 Select and confirm *Yes*.

The method lock is enabled.

Each method will be locked if the AQA2 check is invalid or the AQA2 interval has expired.

Activating AQA2 monitoring for a method

```
<HOME>
[AQA]
├─ AQA2 setup
├─ Method...
```

| AQA2 setup | | 16.01.15 9:52 | |
|--------------|------------------------------|---------------|--|
| Method | 3: A6/25 | | |
| AQA2 | AQA2 active | | |
| Interval | 12 Weeks | | |
| Target value | 4.00 mg/l NH ₄ -N | | |
| Tolerance | 0.50 mg/l NH ₄ -N | | |
| Standard ID | | | |
| Method list | | | |

- 1 Select a method (see section 4.5.3).
- 2 Select and confirm *AQA2*.
- 3 Select and confirm *AQA2 active*.
AQA2 is active for this method.

Defining the AQA2 Interval, nominal value and tolerance

The AQA2 Interval defines the interval between two AQA2 checks. When an interval has expired, the following consequences become effective:

- Warning and loss of the AQA2 labeling

- Locking of the method against measurement (if activated).

Setting range:

1 to 12 weeks (default: 12 weeks) or

1 to 10000 measurements (default: 200 measurements)



The unit of the AQA2 interval (Weeks or Measurements) is defined in the line, *Mode* (see page 144).

| | |
|--------------|------------------------------|
| AQA2 setup | 16.01.15 9:52 |
| Method | 3: A6/25 |
| AQA2 | AQA2 active |
| Interval | 12 Weeks |
| Target value | 4.00 mg/l NH ₄ -N |
| Tolerance | 0.50 mg/l NH ₄ -N |
| Standard ID | |
| Method list | |

- 4 Select the *Interval* and enter the AQA2 interval.
- 5 If necessary, adjust the values for *Target value* and *Tolerance*.
- 6 Optional: Select *Standard ID* and enter a designation. The designation is recorded in the AQA2 documentation.

Repeat the steps 1 to 8 if you want to configure further tests for AQA2.

Carrying out the AQA2 check for a method

```
<HOME>
[AQA]
└ AQA2 check
```

| | |
|---|--------------------|
| AQA2 check | 16.01.15 9:52 |
| Target value | 2.00 |
| To start measurement, insert cell or press <START/ENTER> | |
| 3: A6/25 | NH ₄ -N |
| 16 mm | 0.20 - 8.00 mg/l |

- 1 Carry out the check like a normal measurement (see section 4.5.1 to 4.5.3).
- 2 Insert the cell or start measurement with **<START·ENTER>**.

After the measurement is completed, the result and its evaluation are displayed.

If the check failed, it is possible to repeat the measurement.

If the check was successful, the *AQA2 check* function is finished.

Test record

A test record is displayed after the check. It can be printed and stored as a file (in the internal DataB folder or USB memory device at the USB-A connec-

tion, see section 4.12.1).

Sample printout:

```
photoLab 7600 UV-VIS 09130512 1.30-WTW-1.60 Administrator
AQA2 OK
Protocol ID 32
Executed by: Administrator
Executed 16.01.2015
Valid until: 13.03.2015

Method 6: P6/25 PO4-P
Standard ID CC10 OC557775
Target value 0.80 +- 0.08 mg/l
Measured value 0.84 mg/l
```



Later you can view the last AQA2 test records for all methods monitored with AQA2 under *AQA2 info*.

4.18.4 AQA3/MatrixCheck

The *MatrixCheck* is used to check if the photometric determination is disturbed by other substances present in the sample (sample matrix). The MatrixCheck can be carried out by spiking or diluting:

The photometer enables a simplified MatrixCheck with the aid of the Spectroquant® CombiCheck R-2 addition solution. The MatrixCheck can be carried out immediately. The volumes required for the sample and standards are displayed on the screen. The MatrixCheck is then carried out with a single spiking.

For the MatrixCheck with a standard or your own, however, you can enter the number of spikings or dilutions yourself (max. 3).



If the user administration is active, only users of the user group *Administrator* are allowed to change the settings for AQA checks. The AQA check can be carried out by any user.

MatrixCheck by spiking or diluting

For the MatrixCheck by spiking, the photometric determination is repeated after a defined amount of analyte, which should be determined again, has been added to the test sample in the form of standard solutions.

For the MatrixCheck by dilution, the photometric determination is repeated

after the test sample has been diluted with distilled water.

The nominal value for the determination is calculated from the amount of analyte added (spiking) or from the dilution, provided that there is no disturbance due to the sample matrix. After the photometric determination the measured value is compared to the nominal value expected and the recovery rate is calculated. A matrix disturbance is likely if the recovery rate is less than 90 % or more than 110 %.

Practical instructions

- After evaluating the measured value of the sample the photometer suggests for the MatrixCheck to spike or dilute the sample and standard with suitable volumes.
You can change the suggested values of the volumes for the sample and standard. The photometer checks your entries and informs you of errors (e.g. if a nominal value is outside the measuring range of the test).
For each spiking or dilution, the relevant nominal concentration value is displayed.
- To be able to reliably recognize matrix effects by spiking, the volume increase after spiking should be small.
- To be able to reliably recognize matrix effects by diluting, the dilution factor should be high.
- You can carry out the MatrixCheck as a series of measurements, consisting of up to three determinations with different spiking volumes or dilutions respectively.
- Prepare all test sample solutions simultaneously at the beginning of the series of measurements.

Overview of the AQA3/MatrixCheck

The MatrixCheck consists of the following parts:

- Configuring settings in the *AQA3/MatrixCheck setup* menu.
 - Specify the maximum deviation from the nominal value after spiking or diluting (default setting: 10%)
- Carrying out the AQA3 / MatrixCheck

Specifying the maximum deviation from the nominal value

The assessment of the recovery rate is determined with the maximum deviation from the nominal value. The assessment of the recovery rate is displayed next to the recovery rate after the check has been carried out.

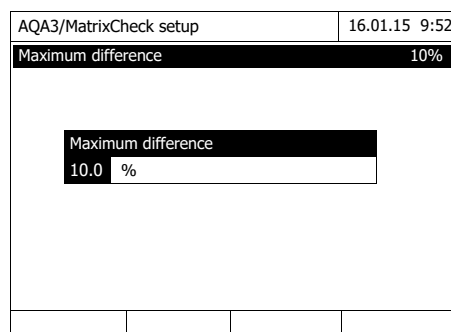
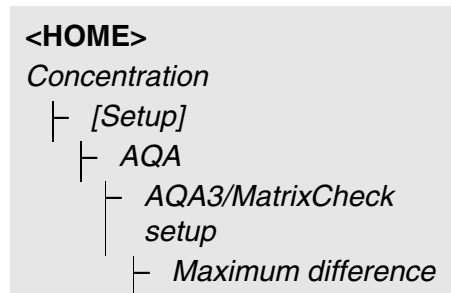

- 1 Enter and confirm a numerical value.
The setting is active.
- 2 Exit the menu with **<ESC>**.

Carrying out the MatrixCheck

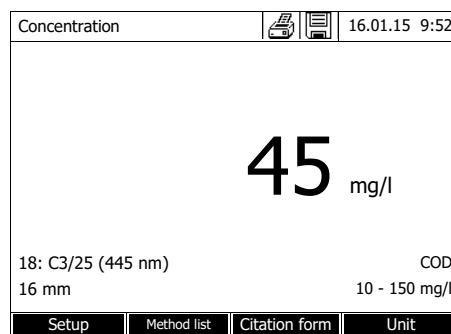

- 1 Measure the original sample without spiking or diluting it (see section 4.5.1 to 4.5.3).
- 2 The measured value is displayed.
- 3 Open the setting menu with **[Setup]**.
- 4 Select and confirm **AQA**.
- 5 If necessary, check the settings in the menu, **AQA3/MatrixCheck setup**.
- 6 Select and confirm **AQA3/Matrix-Check**.

The display for the MatrixCheck opens up.

| | | |
|------------------------|---------------|---------------------|
| MatrixCheck (Spike) | | 16.01.15 9:52 |
| Method | 1: C3/25 | |
| Sample concentration | 45 mg/ICOD | |
| Standard ID | 0 | |
| Standard concentration | 0 mg/ICOD | |
| Sample [ml] | Standard [ml] | Target value [mg/l] |
| 10 | 0 | 45 |
| 10 | 0 | 45 |
| 10 | 0 | 45 |
| Dilute | | Delete Next |

If the spiking with the standard values of the CombiCheck R-2 suggested by the photometer would cause the measuring range to be exceeded, the MatrixCheck by diluting is automatically suggested.



The following description shows the proceeding for the Matrix-Check by spiking. To switch to the MatrixCheck by dilution, use the *[Dilute]* function key. The proceeding is similar there, but the entry of the Standard ID and Standard concentration is not applicable.

| | | |
|------------------------|---------------|---------------------|
| MatrixCheck (Spike) | | 16.01.15 9:52 |
| Method | 1: C3/25 | |
| Sample concentration | 45 mg/ICOD | |
| Standard ID | COD 1500 | |
| Standard concentration | 400 mg/ICOD | |
| Sample [ml] | Standard [ml] | Target value [mg/l] |
| 10 | 0.5 | 62 |
| 10 | 1 | 77 |
| 10 | 1.5 | 91 |
| Dilute | | Delete Next |

7 In the *Standard ID* entry field, select the simplified MatrixCheck with the CombiCheck standard solution or enter a designation for another standard solution used.

If the CombiCheck is selected, no more entries are required (continue with step 10).

8 Enter the concentration of the used standard solution in the *Standard concentration* entry field.

Specifying the series of measurements:

9 Enter the volumes of sample and standard of the individual test sample solutions in the columns, *Sample [ml]* and *Standard [ml]*. The nominal value is calculated after each entry.

- You can delete a measurement from the series of measurements with *[Delete]*.

Note that all nominal values have to be within the measuring range of the test.

10 Using *[Next]*, accept all entries on the page and switch to the next page. The entries are checked by the photometer.

The photometer is ready to carry out the series of measurements.

| MatrixCheck (Spike) | | | | 16.01.15 9:52 |
|----------------------|---------------|---------------------|----------------|---------------|
| Method | | 1: C3/25 | | |
| Sample concentration | | 45 mg/ICOD | | |
| Sample [ml] | Standard [ml] | Target value [mg/l] | nominal [mg/l] | |
| 10 | 0.5 | 62 | 58 | |
| 10 | 1 | 77 | | |
| 10 | 1.5 | 91 | | |
| Back | | Measureme | | Complete |

Carrying out the series of measurements:

According to the program, the samples are measured top down. You can, however, select the samples yourself and thus change the order with *<▲ ><▼ >*.

11 Use *[Measurement]* to proceed to the measurement of the (first) sample.

The measurement display appears.

12 Insert the cell with the respective sample.

The sample is measured.

| | | | | |
|--|--|------------|--|---------------|
| MatrixCheck | | | | 16.01.15 9:52 |
| Method | | 1: C3/25 | | |
| Sample concentration | | 45 mg/ICOD | | |
| Sample | | 10 ml | | |
| Standard | | 0.5 ml | | |
| To start measurement, insert cell or press <START/ENTER> | | | | |
| 16 mm | | | | |
| Back | | | | |

| MatrixCheck | | | | |
|----------------------|---------------|---------------------|----------------|----------|
| Method | | 1: C3/25 | | |
| Sample concentration | | 45 mg/ICOD | | |
| Sample [ml] | Standard [ml] | Target value [mg/l] | nominal [mg/l] | |
| 10 | 0.5 | 62 | 58 | 94 % ✓ |
| 10 | 1 | 77 | | |
| 10 | 1.5 | 91 | | |
| Back | | Measureme | | Complete |

After the measurement, the recovery rate is displayed in the right table column.

The assessment of the recovery rate is displayed next to the recovery rate (✓ or X).

The criteria for the assessment are determined in the menu, *AQA3/MatrixCheck setup / Maximum difference*.

13 If necessary, repeat the steps 11 and 12 for the remaining samples.

14 Use *[Complete]* to complete the MatrixCheck.

The *Save* dialog box pops up.

15 If necessary, change the storage location with *[Location]*: *Internal DataB folder*.

Exchange folder in the instrument or

USB memory:

USB memory device connected at the USB-A connection.

16 If necessary, change the file name.

17 Save the file with **<START·ENTER>**.

The display returns to the measured value display of the original sample without spiking / dilution.

The [MC] status indicator is displayed. A MatrixCheck was carried out for this measured value.

| Concentration | |
|--------------------|---------------|
| [MC] | |
| 45 mg/l | |
| 18: C3/25 (445 nm) | COD |
| 16 mm | 10 - 150 mg/l |
| Setup | Method list |
| Citation form | Unit |

Test record

The result of the MatrixCheck is displayed in a test record. You can print this record and save it as a file.

To save the file on the photometer, select *Internal DataB folder* as the location. To save the file to an external USB memory device connected to the USB-A connection, select *USB memory* as the location (see section 4.12.1).

Sample printout:

| | | | |
|------------------------|----------|---------------|---------------|
| photoLab 7600 UV-VIS | 09130512 | 1.30-WTW-1.60 | Administrator |
| MatrixCheck | OK | | |
| Protocol ID | 7 | | |
| Method | 1: C3/25 | COD | |
| Sample concentration | 45 | mg/l | COD |
| Standard ID | COD 1500 | | |
| Standard concentration | 400 | mg/l | COD |
| Sample | Standard | Target value | |
| Actual value | | | |
| ml | ml | mg/l | mg/l |
| 10 | 0.5 | 625894% | OK |
| 10 | 1 | 777192% | OK |

4.19 User management

The functions of the user management are only available for users of the user group, *Administrator*.

An administrator can

- activate or deactivate the user management for the meter
- create, change or delete individual user accounts.

4.19.1 User levels and user rights

The photoLab® 7600 UV-VIS allows the management of up to 100 users. Every user is member of a user group with defined user rights.

User groups

There are three hierarchical user groups:

- *Administrator* (top level)
- *User* (user account registered by the administrator)
- *Guest* (user without user account)

Administrators and users log in to the photometer with their user name and password. Guests can optionally enter a name for their login. Thus, documented measured values can later be assigned to the user.

User rights in detail

| Action | Administrator | User | Guest |
|-------------------------|---------------|------|-------|
| Select methods | ✓ | ✓ | ✓ |
| Carry out measurements | ✓ | ✓ | ✓ |
| Store measurement data | ✓ | ✓ | ✓ |
| Check photometer (AQA1) | ✓ | ✓ | ⊘ |

| Action | Administrator | User | Guest |
|-------------------------------|---------------|------|-------|
| Check total system (AQA2) | ✓ | ✓ | ⊘ |
| AQA1 measured value labeling | ✓ | ✓ | ✓ |
| AQA2 measured value labeling | ✓ | ✓ | ⊘ |
| Edit user-defined methods | ✓ | ✓ | ⊘ |
| Exchanging methods / profiles | ✓ | ⊘ | ⊘ |
| Change AQA settings | ✓ | ⊘ | ⊘ |
| Clear the memory | ✓ | ⊘ | ⊘ |
| Set the date and time | ✓ | ⊘ | ⊘ |
| Administrate users | ✓ | ⊘ | ⊘ |
| Reset photometer settings | ✓ | ⊘ | ⊘ |
| Carry out software update | ✓ | ⊘ | ⊘ |



You can also switch off the user management and reactivate it as necessary. To do so, you need administrator rights. If the user management is switched off, the user name and password do not have to be entered. Each user has full rights.

4.19.2 Activating or deactivating the User management function

Each user can activate the user management function.

If the function is deactivated, each user has administrator rights.

Only members of the user group, administrator can deactivate the user management function.

If the function is active, each user has to log in to the photometer. After the login, the user has certain rights depending on the user group.

Activating the user management function

```
<HOME>
[General setup]
└ User management
```

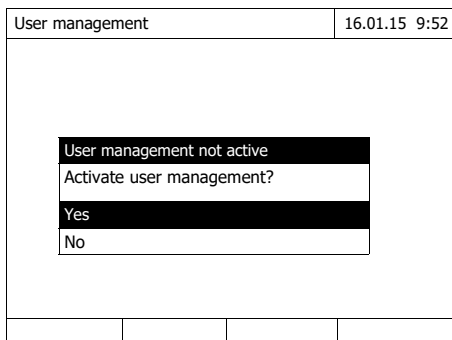

- 1 Select and confirm **Yes**.
The user management function is active.
Activating the user management creates an administrator user account. The user name is "Administrator". The preset password is "admin". Change this password as soon as possible.

Deactivating the user management function

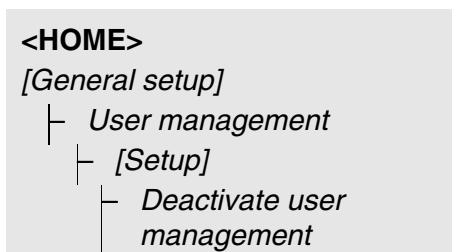

The user management function is inactive.
Each user has administrator rights.



If the user management is deactivated by a user of the *Administrator* user group, all user accounts that were set up are lost. The password for the administrator is reset to "admin".

4.19.3 Creating, changing or deleting a user account

When the user management function is active, a user with administrator rights can administrate user accounts.

Creating a user account

During the creation of a user account, the *Name*, whether or not the user belongs to a *User group* and the *Password* are defined.

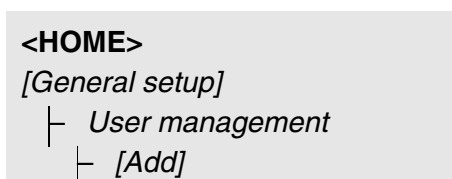

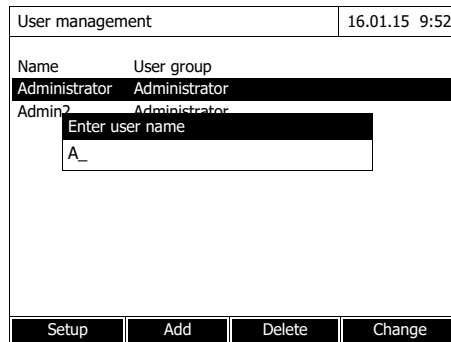

The input field for the new user name pops up.

- 1 Enter the user name (<A...9>) and confirm.

The selection field for the user group (*Administrator / User*) pops up.

- 2 Select and confirm the user group.

The input field for the password pops up.

- 3 Enter the password (<A...9>) and confirm.

The user account is created and appears in the list of user accounts.

Editing a user account

When a user account is changed, the *User group* and *Password* can be changed.

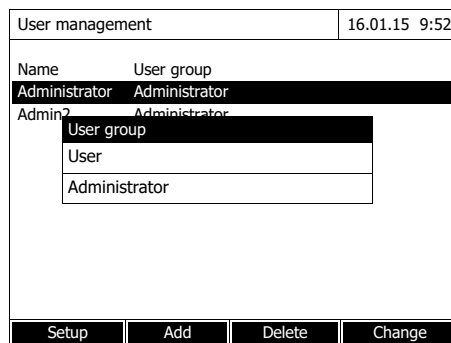
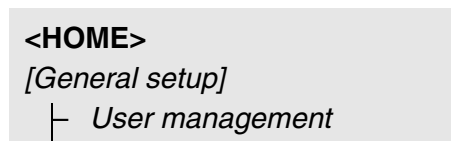

- 1 Select a user account.
- 2 Press [*Change*] to edit the user account.

The selection field for the user group (*Administrator / User*) pops up.

- 3 If necessary, select and confirm another user group.

The input field for the password pops up.

- 4 If necessary, enter (<A...9>) and confirm another password.

The user account is changed and appears in the list of user accounts.

Deleting a user account

```
<HOME>
[General setup]
├─ User management
```

- 1 Select a user account.
- 2 Delete the user account with *[Delete]*.
A security prompt appears: *Confirm deletion ?*
- 3 Confirm the security prompt.
The user account is deleted.

4.19.4 Login with active user management

To be able to always assign measurement data to a user, the administrator can activate the user management function. After doing so, the photometer can only be operated after login with a user name. Depending on the authorization class (administrator, user, guest), important settings are released for changes or locked.



The user management function is not active in the delivery condition of the photoLab® 7600 UV-VIS. Every user can carry out all functions.

Activating the user management creates an administrator user account. The user name is "Administrator". The preset password is "admin". Change this password as soon as possible.

Make sure to use the correct spelling (upper and lower case) of user name and password for the login.

After logging in to the *Administrator* group with a user name, you can create further users or administrators or switch off the user management function.

The *Login* window with the *Enter user name* prompt appears after the meter has been switched on and after a user has logged off. In the following example, a user will log in with the user name, "Administrator".

The photometer is switched on.
The *Login* dialog is displayed.

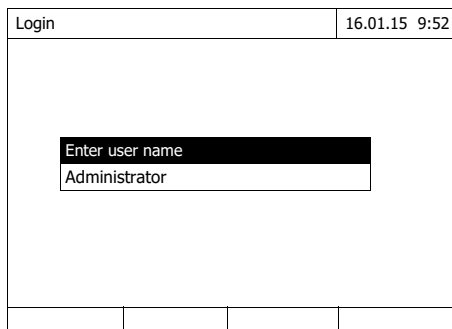

1 Enter the user name (<A...9>) and confirm.

The input field for the password pops up.

If the user name is not known (or incorrectly spelled) it is possible to log in without a password as a guest with restricted rights (see section 4.19.1).

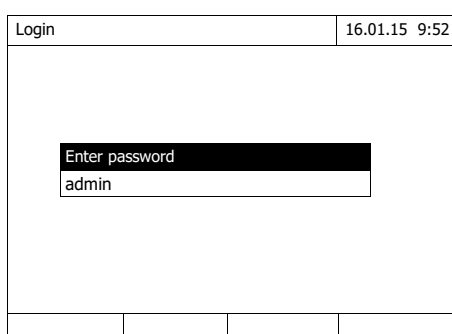

2 Enter the password (<A...9>) and confirm.

If the password is written correctly (note upper and lower case), the main menu *Home* opens up. The user name that was entered is displayed.

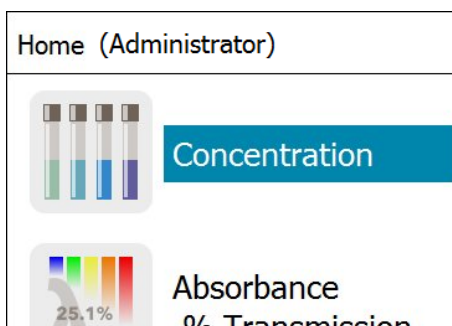

4.19.5 Changing the password

The administrator sets up user accounts and assigns a password to each user account.

As soon as any user has successfully logged in with the password, they can change the password for their user accounts themselves.

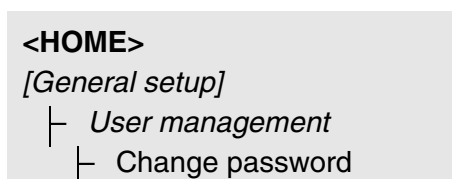

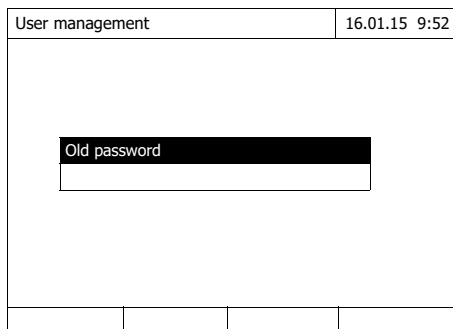

- 1 Enter and confirm the old password.
 - 2 Enter and confirm the new password.
- The password is changed.

4.20 Reset

You can reset (initialize) the measurement settings or all settings.



The *Reset* function is available for users of the user group, Administrator only.

You have the following options of resetting the photometer settings:

| | |
|--|---|
| <ul style="list-style-type: none"> ● <i>Reset configuration</i> | <p>All settings except for the measurement data memory, user-defined methods and measured blank values are deleted.</p> |
| <ul style="list-style-type: none"> ● <i>Delivery condition</i> | <p>All settings (including measurement data memory and user-defined methods) are deleted and the photometer is reset to the delivery condition.</p> |
| <ul style="list-style-type: none"> ● <i>Internal DataB folder</i> | <p>The measurement data memory is erased. All other settings are retained.</p> <p>Save your measurement data (e.g. to a USB memory device) before erasing the internal data memory of the photometer.</p> |

<HOME>
 [General setup]
 └ Reset

The menu where to select the reset type (*Delivery condition / Reset configuration*) is displayed.

- 1 Select and confirm the reset type.
The reset is carried out.

4.21 Photometer information ([Info])

The following photometer information is displayed:

- Photometer designation
- Version number of the meter software/method data
- Hardware version
- Series number of the meter
- Registered user
- Hardware status (for service purposes)
- Memory status

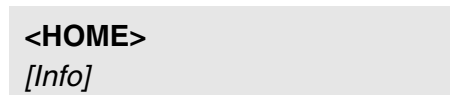

| Info |  | 16.01.15 9:52 |
|----------------------------|---|---------------|
| Model designation: | photoLab® 7600 UV-VIS | |
| Serial number: | 15150001 | |
| Software/methods version: | 2.18-WTW-2.20 | |
| IQ-LabLink version: | 1.20 | |
| Build: | 25.02.15 11:57 | |
| Hardware version: | 0-1-0-22-50-- | |
| Hardware status: | FF 00000000 | |
| Lamp counter | 12 | |
| System test | ✓✓ | |
| Filter test | ✓✓ | |
| Lamp test | ✓✓ | |
| Wavelength calibration | ✓✓ | |
| Free internal memory space | 5046 KB | |
| Registered user | ✓ | |

The meter information and result of the self-test are displayed and can be printed.

4.22 Lamp counter

The photometer counts the operating hours of the lamp. The information on the operating hours of the lamp is given in the *Info* menu.

The number quoted there corresponds to the number of flashes.

4.23 Software and methods update

The software and method update is used to continuously update your photometer.



If the user administration is activated, only users of the user group *Administrator* may carry out any software and method updates.

The update comprises

- the newest firmware (meter software)
- new or changed method data



User-defined data (such as settings, user-defined methods or measured data) are not changed by a software and methods update.

The current software version is available on the Internet under <http://www.WTW.com>.

Transfer to the photometer is done with a USB memory device (flash drive) as a temporary storage.

Store the new software required for the update on the USB memory device and connect it to the photometer.

Execution

- 1 Connect the USB memory device to the PC.
- 2 Unpack the contents of the downloaded exe or zip file with the complete folder structure in the main directory (top level) of the USB memory device.



Make sure the folder structure of the files is retained while the files are unpacked.

If you use a program such as WinZip for unpacking, the option, "Nutze Ordnernamen" or "Use Folder Names" must be set. Details are given in the documentation of the unpack program.

The "Update" folder must be on the top level of the USB memory device. The Update folder contains several subfolders.

The following steps are carried out at the photometer.

- 3 Connect the USB memory device to the photometer.
- 4 Switch on the photometer if necessary.

```
<HOME>
[General setup]
├─ Software/methods update
```

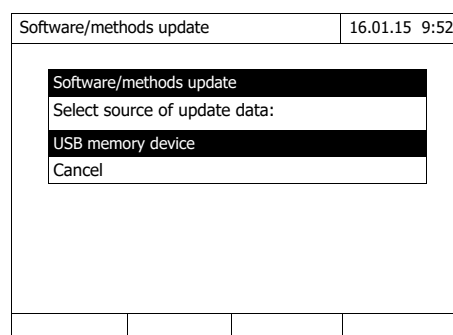

- 5 Using <▲><▼>, select *USB memory device* as the source and press <START·ENTER>.

The update process takes approx. five minutes.

The photometer switches itself off and then on again.

If the update cannot be carried out, an error message is displayed.



Check whether the "Update" folder with its subfolders is stored on the USB memory device (top level).

If on the photometer there is not enough free memory capacity for the update, you can create memory capacity by erasing measurement data. Save your data to a USB memory device before erasing them on the photometer.

Remote functions

The photometer has a programming interface for remote control. More detailed information on this is available on request from the manufacturer.

The photometer can also process a script file stored on a USB flash drive. This function is among the general settings of the photometer. More detailed information on the function and the requirements of the script file is available on request from the manufacturer.

5 Maintenance and cleaning

5.1 Exchanging the buffer battery



CAUTION

There is a risk of explosion if unsuitable batteries are used. Only use leakproof alkaline manganese batteries.



If you leave the photometer switched on during the exchange or insert the new batteries within a minute after taking out the old ones, the date and time are retained in the photometer.

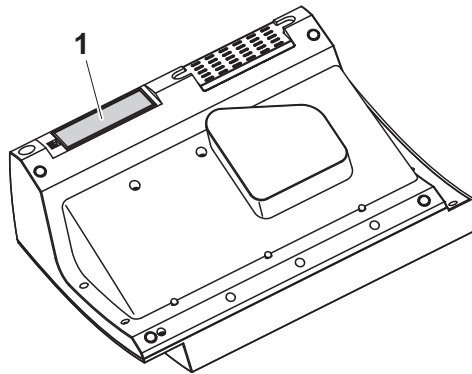

- 1 Turn the photometer upside down and place it on a soft surface.
- 2 Open the lid of the battery compartment (1).
- 3 Remove the old batteries from the battery compartment.
- 4 Insert the four new batteries in the battery compartment. Make sure that the poles of the batteries are in the correct position.
- 5 Close the lid of the battery compartment.

Disposal of batteries

Dispose of the batteries at a suitable facility according to local legal requirements. It is illegal to dispose of the batteries with household refuse.

Within the European Union, the batteries are removed at a specialized treatment center at the instrument's end of life. The instruments are taken to one of those specialized treatment centers via the recycling system set up for this purpose.

5.2 Cleaning

Especially after a cell has broken or after a reagent accident, the photometer should immediately be cleaned (see also section 6.1 ACTIONS IN THE CASE OF A BROKEN CELL).

NOTE

The housing components are made out of synthetic materials (ABS, PMMA and PC). Thus, avoid contact with acetone, ethyl alcohol and similar detergents that contain solvents. Remove any splashes immediately.

5.2.1 Cleaning the enclosure

Clean the photometer enclosure as follows:

- If the housing surface is dirty, wipe it with a soft cloth and mild soapy water.
- Remove any chemicals splashes as soon as possible.
- For disinfection, you can use isopropanol for cleaning for a short time.

5.2.2 Cleaning the cell shaft



If a cell has broken, the cell shaft has to be cleaned immediately. To do so, proceed as described in section 6.1.

Normally, it is not required to clean the cell shaft routinely. Remove dust and slight contamination with a moist, lint free cloth. Use isopropanol briefly to remove persistent coatings (e.g. reagent remains). Especially clean the bottom parts of the lateral surfaces of the rectangular cell shaft where the light barriers for the automatic cell recognition are located.

5.2.3 Cleaning the detector lens

Normally, it is not required to clean the detector lens routinely. Cleaning the detector lens can be necessary in the following cases:

- If the lens is visibly smudged, e.g. after a cell has broken or after a reagent accident (see also section 6.1 ACTIONS IN THE CASE OF A BROKEN CELL).
- If, due to environmental influences or reagent contamination, the photometer displays the message, *Wavelength calibration* during the self-test after being switched on (see section 6.2)



If the lens is often smudged (error, *Wavelength calibration* during the self-test), check whether the correct operating conditions are observed. Follow the details in section 3.2 for this purpose.

Proceed as follows to clean the detector lens:

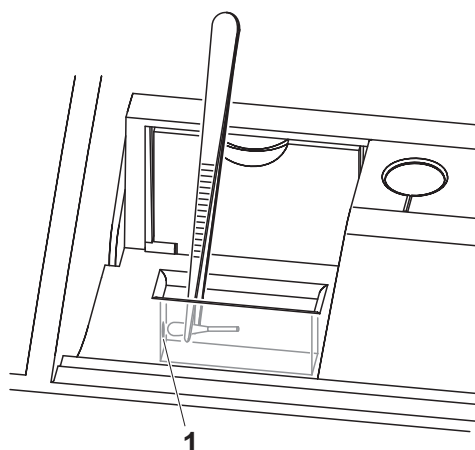

The detector lens is on the front left side of the rectangular cell shaft (pos. 1).

- 1 Switch off the photometer.
- 2 Cut off one end of a customary cotton swab (approx. 2 cm).
- 3 Grasp the cut-off end with the tip of a pair of tweezers or small pliers. Clean the lens with the dry head of the cotton swab. To do so, move the head from the center of the lens outward in circles. If there are persistent coatings, moisten the cotton swab with a little deionized water or isopropanol.



After recommissioning, carry out the photometer monitoring for all measurements (see section 4.18.2 PHOTOMETER MONITORING (AQA1)).

6 What to do if...

6.1 Actions in the case of a broken cell



WARNING

Cells can contain dangerous substances. If the contents are released, follow the safety instructions of the package insert. If necessary, take corresponding protective measures (protective goggles, protective gloves etc.).



CAUTION

Do not turn the photometer upside down or laterally to remove the liquid!

When doing so, the liquid could come into contact with electronic components and damage the photometer.

The photometer has a drain device through which the contents of a broken cell can drain off without causing any damage.

Proceeding after a cell has broken

- 1 Switch off the photometer and disconnect it from the power supply.
- 2 Let the liquid drain off into a suitable container and dispose of it properly according to the instructions of the reagent package.
- 3 Carefully remove all broken glass, e.g. with tweezers.
- 4 Carefully clean the cell shaft using a moist, lint-free cloth. If there are persistent coatings, use isopropanol for a short time. Especially clean the bottom parts of the lateral surfaces of the rectangular cell shaft where the light barriers for the automatic cell recognition are located.
- 5 Let the cell shaft dry.



After recommissioning, carry out the photometer monitoring for all measurements (see section 4.18.2).

If, after recommissioning, an error occurs during the wavelength calibration, the detector lens is probably smudged. In this case, clean the lens according to section 5.2.3 CLEANING THE DETECTOR LENS.

6.2 Error causes and remedies

| | | |
|--|---|---|
| Meter does not react to keystroke | Cause | Remedy |
| | <ul style="list-style-type: none"> – Operating condition undefined or EMC load unallowed | <ul style="list-style-type: none"> – Processor reset: Press the <ON/OFF> and <ESC> key simultaneously. |

| | | |
|----------------------------------|---|---|
| Audio signal on keystroke | Cause | Remedy |
| | <ul style="list-style-type: none"> – The key does not have any function in the current operating state | <ul style="list-style-type: none"> – Press the appropriate key |

| | | |
|---|--|--|
| Measuring range undercut or exceeded | Cause | Remedy |
| | <ul style="list-style-type: none"> – Measuring range or method not suitable | <ul style="list-style-type: none"> – Select method with suitable measuring range – Dilute the sample |



In *Concentration* mode you can display the current absorbance value as an additional information (*[Setup]/Display absorbance*, see also section 4.5.6).

| | | |
|--|--|--|
| Self-test does not start. The instrument displays <i>Please remove cell</i> | Cause | Remedy |
| | <ul style="list-style-type: none"> – A cell is inserted in one of the cell shafts | <ul style="list-style-type: none"> – Remove the cell – Then press the <START·ENTER> key |
| | <ul style="list-style-type: none"> – A foreign object is inserted in one of the cell shafts | <ul style="list-style-type: none"> – Remove foreign object – Then press the <START·ENTER> key |
| | <ul style="list-style-type: none"> – Occasionally, the instrument carries out an automatic readjustment for the rectangular cell recognition. The informative message <i>Please remove cell</i> is displayed even when no cell is inserted. | <ul style="list-style-type: none"> – Press the <START·ENTER> key. |

| Cause | Remedy |
|----------------------------------|---|
| – The cell shaft is contaminated | – Clean the cell shaft (see section 5.2.2 and section 6.1) – Restart the instrument – If necessary, confirm the <i>Please remove cell</i> message with <START·ENTER> . |
| – Instrument defective | – Please contact the service department. |

Obviously incorrect measured values

| Cause | Remedy |
|--------------------------------|-----------------------------|
| – Cell contaminated | – Clean the cell |
| – Dilution set incorrectly | – Set the dilution |
| – Selected method not suitable | – Select different method |
| – Zero measurement incorrect | – Perform zero measurement |
| – Blank value incorrect | – Remeasure the blank value |

Automatic bar code recognition selects wrong method

| Cause | Remedy |
|--|---|
| – Barcode on the cell cannot be read correctly | – Clean the cell – Deactivate the automatic bar code recognition function (mode <i>Concentration / [Setup]</i>) |

Fluctuating measured values

| Cause | Remedy |
|-------------------------|------------------------------|
| – Cell shaft cover open | – Close the cell shaft cover |

Self test failed.

| Cause | Remedy |
|---|--|
| – <i>System test</i> : Instrument defective | – Please contact the service department. |
| – <i>Filter test</i> : Instrument defective | – Please contact the service department. |

| | Cause | Remedy |
|---|--|--|
| | <ul style="list-style-type: none"> – <i>Wavelength calibration:</i> <ul style="list-style-type: none"> – Foreign particle in the cell shaft – Lens smudged – Instrument defective | <ul style="list-style-type: none"> – Remove foreign object – Clean the lens (see section 5.2.3 or section 6.1). If this happens repeatedly, check the operating conditions (see section 3.2) – Please contact the service department. |
| Connected printer does not print | <ul style="list-style-type: none"> – Printer not suitable | <ul style="list-style-type: none"> – Connect a printer that can interpret the required printer control language (see section 4.17.1 PRINTER AND TERMINAL PROGRAMS) |
| Data transmission to USB memory device does not work | <ul style="list-style-type: none"> – Connected USB memory device was not recognized – The USB memory device has been formatted to a file system which is not supported, e. g. NTFS | <ul style="list-style-type: none"> – Use other USB memory device – Format the USB memory device to the FAT 32 file system |

7 Technical data

7.1 Measurement characteristics

Measuring principle Spectrophotometer with reference beam technology

| | | |
|---------------------|------------------|---|
| Light source | Lamp type | Xenon flashlamp |
| | Average lifetime | 5×10^8 flashes, corresponding to at least 13000 h in permanent operation |

| | | |
|----------------------|-------------------------|---|
| Monochromator | Type | Grating monochromator with step motor |
| | Wavelength range | 190 - 1100 nm |
| | Max. scan speed | approx. 1000 nm/min |
| | Wavelengths calibration | Automatic |
| | Accuracy | ± 1 nm |
| | Reproducibility | $\pm 0.5 \pm$ nm (checkable, e.g. with holmium oxide filter) |
| | Resolution | 1 nm |
| | Spectral band width | 4 nm |

| | | |
|--------------------------------|-------------------|---|
| Photometric measurement | Light sensor | Photo diode |
| | Measuring range | $A = -3.300$ to $A = +3.300$ |
| | Linearity | $< 1\%$ for $A \leq 2.000$ in the range 340 ... 900 nm |
| | Accuracy* | $\pm 0.003 A$ for $A < 0.600$ $\pm 0.5\%$ of the reading for $0.600 \leq A \leq 2.000$ |
| | Reproducibility * | ± 0.002 at $A = 1.000$ |
| | Resolution | $\Delta A = 0.001$ |
| | Stray light | $< 0.05\%$ transmission at 340 and 408 nm |

* in the range 200 nm ... 1000 nm

| | | |
|---------------------|--|--|
| Usable cells | Round cells | <ul style="list-style-type: none"> – Outer diameter: 16 mm – Inner diameter: 13.6 mm – Flat cell bottom |
| | Rectangular cells* | <ul style="list-style-type: none"> – Path length: 10 mm, 20 mm and 50 mm – Maximum width: 12.6 mm |
| | Minimum filling level | 20 mm |
| | Minimum filling volume | Round cell 16 mm: 4 ml Rectangular cell, 10 mm: 2 ml Rectangular cell, 20 mm: 4 ml Rectangular cell, 50 mm: 10 ml |
| | Center height (for rectangular cells) | 12.5 mm |
| | Cell recognition | Automatic for most types |

* Depending on the wavelength range, different kinds of cells are suitable. Apart from round cells, all rectangular cell made of glass, quartz or plastic with opaque lateral surfaces are suitable (see section 8.1). Cells with clear or serrated lateral surfaces are not reliably recognized by the automatic cell recognition. Especially with plastic single-use cells we recommend you test them for suitability prior to carrying out large-scale series of measurements. For measurements in the UV range below 320 nm, glass cells and commercial PS plastic cells are not suitable; below 280 nm, commercial PMMA plastic cells are not suitable due to their transmission characteristics. Therefore, use quartz cells or tested single-use cells (plastic) for applications in the UV range.

Measuring modes

- Concentration
 - Measurement with permanently programmed methods, adapted to the WTW test set program
 - Automatic method selection if test sets with barcodes are used
 - Program support for the creation of additional user-defined methods (max. 100)
 - Citation forms and units method dependent
 - Display of the absorbance value can be added
 - Method data update possible via Internet

- Absorbance / % Transmission
 - Measurement against own reference absorbance value possible
- Multi wavelengths
 - Freely definable calculations from absorbance values at up to 10 different wavelengths
 - Calculations can be stored as methods (max. 499)
- Measuring modes**
 - Spectrum
 - Absorbance or % transmission mode
 - Limits freely selectable within the wavelength range
 - Increment: 1 nm
 - Recording duration for the complete wavelength range: < 7 min
 - Settings can be stored as profiles
 - Evaluation functions: Cursor scanning, zoom, min./max. recognition, peak area determination, derivation, smoothing, multiplication by constants, addition of constants, addition and subtraction of spectra, formation of the quotient of two spectra
 - Kinetics
 - Absorbance or % transmission mode
 - Minimal adjustable scan interval: 1 s (if the absorbance of the test sample is high, the scan interval is extended due to the longer duration of the individual measurements)
 - Settings can be stored as profiles (max. 20)
 - Evaluation functions: Cursor scanning, zoom, min./max. determination, slope calculation (for an interval or total), enzymatic activity
 - OptRF measurement
 - Measurement with permanently programmed methods for which no test sets are required
 - Citation forms method dependent

7.2 Measured value documentation and quality assurance

| | | |
|-----------------------------------|---------------------|--|
| Memory for measured values | Memory capacity | <ul style="list-style-type: none"> – 5000 single measured values from the measuring modes, concentration, absorbance / % transmission and multi wavelengths – 40 MByte internal memory, sufficient for approx. 500 spectra and 400 kinetic curves (sample values based on the following assumptions: All spectra over a wavelength range of 600 nm and all kinetic curves with 150 single values each) |
| | Output options | USB memory device, printer, PC |
| | File formats | ASCII, *.csv |
| Monitoring functions | AQA1 | Check of the photometer |
| | AQA2 | Check of the total system |
| | AQA3 | Check of the sample matrix |
| User management | Can be switched off | yes |
| | User accounts | 3 hierarchical levels (administrator, user, guest) |
| | Password protection | for administrators and users |

7.3 General meter data

| | |
|------------------------------------|---|
| Dimensions | 404 x 197 x 314 mm (width x height x depth) |
| Weight | approx. 4.5 kg (without plug-in power supply) |
| Housing type of protection | IP 30 |
| Electrical protective class | III |
| Test certificates | CE |

| | | |
|---|--|---|
| Allowed environmental conditions | Temperature | Operation: +10 °C to + 35 °C (41 °F to 95 °F) Storage: -25 °C to + 65 °C (-13 °F to 268 °F) |
| | Humidity | Yearly mean: ≤ 75 % 30 days/year:95 % Other days: 85% |
| | Climatic class | 2 |
| Power supply | Power pack | Type: EDACPOWER EA1036R Input: 100 - 240 V ~ / 50 - 60 Hz / 1 A Output: 12 V = / 3 A (In compliance with Eco-design directive 2009/125/EC, EuP step 2) |
| Guidelines and norms used | EMC | EC directive 2004/108/EC EN 61326-1 – Interference emission: Class B – Interference immunity: IEC 61000-4-3 Tolerance extension: 0.008 E FCC Class A |
| | Meter safety | EC directive 2006/95/EC EN 61010-1 |
| | Climatic class | VDI/VDE 3540 |
| | IP protection class | EN 60529 |
| Communication interfaces | Ethernet | RJ45 |
| | USB | – 1 x USB-A (for printer, USB memory devices, keyboard or bar code reader) |
| Other features | <ul style="list-style-type: none"> ● Drain for spilled cell contents ● Photometer software update and method data update possible via Internet | |

**Available
languages**

- German
- English
- Français
- Español
- Italiano
- Bulgarian/Български
- Česko
- Simplified Chinese/ 中文
- Traditional Chinese/ 繁體中文
- Dansk
- Dutch
- Greek/Ελληνικά
- Indonesian/Indonesia
- Japanese/ 日本語
- Korean
- Magyar
- Malay/Melayu
- Macedonian/Македонски
- Norsk
- Polski
- Português
- Romanian/Română
- Russian/Русский
- Serbian/Srpski
- Slovenščina
- Svenska
- Thai/ ภาษาไทย
- Turkish/Türkçe
- Vietnamese/Việt

8 Accessories and options

8.1 Accessories

Cells for the WTW test set program

| Description | Model | Order no. |
|---|--------------|-----------|
| 25 empty round cells (16 mm) | RK 14/25 | 250621 |
| Rectangular cell, 10 mm | REK 10 | 250605 |
| Rectangular cell, 20 mm | REK 20 | 250600 |
| Rectangular cell, 50 mm | REK 50 | 250614 |
| Rectangular cell, quartz, 10 mm | REK 10 Quarz | 250606 |
| Rectangular cell, quartz, 20 mm | REK 20 Quarz | 250601 |
| Rectangular cell, quartz, 50 mm | REK 50 Quarz | 250615 |
| 100 PMMA disposable rectangular cells, 10 mm | REC 10 PMMA | 250607 |
| Half micro cells, optical special glass, 50 mm | REC 50/2 | 250616 |
| Stand aid for 10 mm PMMA disposable rectangular cells | PL6-10 SIC | 250213 |

Case and cable for mobile use

| Description | Model | Order no. |
|-------------------------|------------------|-----------|
| Case for photoLab® 7xxx | FC spectral 6000 | 250212 |

PC software

| Description | Model | Order no. |
|--|---------------------------------|-----------|
| PC software package for CIE-based color measurement and convenient data management | photoLab® Color + Data spectral | 902763 |

Application packages

| Description | Model | Order no. |
|--|----------|-----------|
| Brewing application package (German/English) | PL6-BREW | 250214 |

8.2 Test equipment

| Test equipment | Description | Model | Order no. |
|----------------|-----------------------------------|---------------------|-----------|
| | Test equipment for AQA1 | PhotoCheck 14693 | 250490 |
| | Test equipment for pipette volume | PipeCheck 14692 | 250498 |



Standard solutions for the WTW test set program are listed in the WTW catalog or on the Internet.

8.3 Optional equipment

The following optional extensions are available in specialist shops:

- USB barcode reader (hand scanner)
- USB PC keyboard
- 12 V power supply unit (e.g. portable power source or car battery) for mobile operation of the photometer
- 12 V vehicle connection cable for the mobile operation of the photometer by means of a 12 V power source

Suitable are vehicle connection cables with the following characteristics:

| | |
|------------------------------------|-------------|
| Voltage | 12 V |
| Amperage | 8 A |
| Barrel connector | 2.5 x 5.5mm |
| Positive pole at the inner contact | |

8.4 Connection cable:

PC You can connect a PC to the photoLab® 7600 UV-VIS in one of the following ways:

| Description | Order no. |
|-----------------------------------|------------------|
| – Cable with USB-B and USB-A plug | Specialist shops |

USB printer You can connect a USB printer to the photoLab® 7600 UV-VIS:

| Description | Order no. |
|-----------------------------------|------------------|
| – Cable with USB-B and USB-A plug | Specialist shops |

Appendix

A.1 Glossary

| | |
|------------------------------|---|
| Absorbance | Logarithmic dimension for the absorption of the sample; negative decadic logarithm of the transmission. |
| Analysis instructions | The exact proceeding to carry out the detection procedure is described in the analysis instructions. |
| AQA | Analytical Quality Assurance. |
| AQA labeling | In the documentation, measured values are given an AQA labeling (AQA1 or AQA2), depending on whether or not the measurement was carried out with AQA and with which AQA level. |
| AQA1 | 1st step of the analytical quality assurance: Monitoring of the instrument. |
| AQA2 | 2nd step of the analytical quality assurance: Monitoring of the total system. |
| AQA3 | 3rd step of the analytical quality assurance: Check of whether the photometric determination is disturbed by other sample ingredients (sample matrix). The MatrixCheck can be carried out by spiking or diluting: |
| AutoSelector | Plastic cylinder with bar code. It is inserted in the round cell shaft and transmits the code for a reagent test set to the photometer. |
| Barcode | Optical code (black and white bars) of the method that can be read by light barriers in the photometer. |
| Baseline | Reference value for the spectrum of reference absorbances or reference transmissions. |
| Cell | Vessel to take a liquid sample for measurement in a photometer. The cell material (mostly glass) must have certain optical features to be suitable for photometry. |
| Citation forms | Different display formats that can be derived from each other of the measured value for a concentration. The method for the determination of phosphate, e.g. supplies a measured value for phosphorous P. This measured value can alternatively be given in the citation forms PO ₄ , PO ₄ -P or P ₂ O ₅ . |
| CombiCheck | Multiparameter standards used to check the total system for a method. |
| Concentration | Mass or amount of a dissolved substance per volume, e. g. in g/L or mol/L. |

| | |
|--------------------------------|---|
| Correlation coefficient | Specifies the extent of the linear relationship of value pairs when determining the zero point and slope for a user-defined method. |
| Detection procedure | The detection procedure designates the general principle of how a sample is brought into a form suitable for measurement. Different methods can be based on the same detection procedure. |
| Kinetics | Measurement over a period of time. |
| MatrixCheck | see AQUA3. |
| Measured value | The measured value is the special value of a measured parameter to be determined. It is given as a combination of the numerical value and unit (e. g. 3 m; 0.5 s; 5.2 A; 373.15 K). |
| Method | A method comprises a chemical detection procedure and special method data (calibration line) required to evaluate the measurement results. How to carry out the method up to measuring with the photometer is described in the analysis instructions. The photoLab® 7600 UV-VIS contains a database with methods. Furthermore, user-defined methods can be entered in the database as well. |
| PhotoCheck standard | Stable color solution with defined absorbance values for the check of the photometer. |
| Reagent blank value | The evaluation of the photometric measurement always refers to the comparison value of a test sample without the substance to be determined (reagent blank value). Thus the influence of the basic absorbance of the reagents on photometric measurement is compensated for. |
| Recovery | The recovery rate is the found measured value divided by the default value (percentage). Example: Default value 20 mg/l; Found 19.7 mg/l => recovery 0.985 or recovery rate 98.5%. |
| Reference absorbance | With the reference absorbance, the basic absorbance stored in the photometer can be replaced by a measurement of your own. |
| Reset | Restoring the original condition of all settings of a measuring system. |
| Sample blank value | Absorbance value of the original test sample, handled according to prescription but without color reagent. |
| Spectrum | Distribution of the intensity, transmission or absorbance depending on the wavelength. |
| Standard | Sample with a defined concentration of the analyte to be determined. |

| | |
|------------------------|---|
| Test sample | Designation of the test sample ready to be measured. Normally, a test sample is made by processing the original sample. The test sample and original sample are identical if the test sample was not processed. |
| Test set (test) | A test set contains all reagents that are required for the photometric determination of the sample according to the analysis instructions. |
| Transmission | The part of the light that goes through the sample. |
| Turbidity | Light attenuation caused by diffuse scattering at undissolved substances. |
| Zero adjustment | Adjusting a photometer with a water-filled cell. |

A.2 List of trademarks

| Trademark | Owner |
|------------------|-----------------------|
| CertiPUR® | Merck KGaA |
| Microsoft® | Microsoft Corporation |
| Spectroquant® | Merck KGaA |
| Windows® | Microsoft Corporation |

3 Disposal

Handle and dispose of all waste in compliance with local laws and regulations.

EU only: Correct disposal of this product — WEEE Directive on waste electrical and electronic equipment

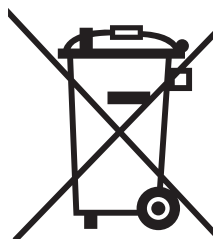

This marking on the product, accessories or literature indicates that the product should not be disposed of with other waste at the end of its working life.

To prevent possible harm to the environment or human health from uncontrolled waste disposal, please separate these items from other types of waste and recycle them responsibly to promote the sustainable reuse of material resources.

Waste from electrical and electronic equipment can be returned to the producer or distributor.



EU only: Correct disposal of batteries in this product

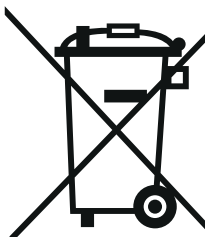

This marking on the battery, manual or packaging indicates that the batteries in this product should not be disposed of with other waste at the end of its working life. Where marked, the chemical symbols Hg, Cd or Pb indicate that the battery contains mercury, cadmium or lead above the reference levels in Directive 2006/66/EC. If batteries are not properly disposed of, these substances can cause harm to human health or the environment.

To protect natural resources and to promote material re-use, please separate batteries from other types of waste and recycle them through your local, free battery return system.

A.4 Index

A

| | |
|--|-----|
| Absorbance / % Transmission, measuring | 68 |
| Accessories | 176 |
| Analysis timer | 110 |
| Analytical quality assurance (AQA) | 138 |
| AQA | 138 |

B

| | |
|---------------------|----|
| Barcode | 38 |
| Barcode reader | 21 |
| Blank value | |
| Reagent blank value | 47 |
| Sample blank value | 45 |

C

| | |
|---------------------------|-----|
| Cell breakage | 166 |
| Cleaning | 164 |
| Commissioning | 14 |
| Concentration measurement | 38 |
| Connections | 7 |
| Copyright | 2 |

D

| | |
|--------------|-----|
| Dataset | 114 |
| Date/time | 33 |
| Disinfection | 164 |

E

| | |
|--------------------|-----|
| Ethernet interface | 123 |
|--------------------|-----|

G

| | |
|----------|-----|
| Glossary | 179 |
|----------|-----|

I

| | |
|-----------------------|-----|
| Initial commissioning | 15 |
| Initialization | 159 |
| Instrument settings | 32 |
| IQ LabLink | 67 |

K

| | |
|--------|---|
| Keypad | 8 |
|--------|---|

| | |
|----------|----|
| Kinetics | 99 |
|----------|----|

M

| | |
|---------------------------|---------------|
| Measure diluted sample | 44, 87 |
| Measured value memory | 115, 116, 117 |
| Measurement dataset | 114 |
| Meter information | 160 |
| Method | 78 |
| Methods update | 161 |
| Multi-wavelengths methods | 71 |

O

| | |
|----------------------|----|
| Operating elements | 7 |
| Operating principles | 25 |
| Overview | 7 |

P

| | |
|--------------------|-----|
| Print | 136 |
| Printer | 136 |
| Profile (kinetic) | 102 |
| Profile (spectrum) | 92 |

R

| | |
|----------------------|-----|
| Reagent blank value | |
| Measuring the | 49 |
| Reference absorbance | 69 |
| Reset | 159 |

S

| | |
|-------------------------|-----|
| Safety | 11 |
| Sample blank value | 45 |
| Saving | 112 |
| Scope of delivery | 14 |
| Self-test | 23 |
| Socket field | 7 |
| Software update | 161 |
| Software version number | 160 |
| Standard adjustment | 50 |
| Switching on | 23 |
| System info | 160 |
| System management | 32 |

T

| | |
|----------------|-----|
| Technical data | 170 |
|----------------|-----|

| | |
|----------------------------|-----|
| Timer | 109 |
| Turbidity correction | 57 |

U

| | |
|-------------------------|--------|
| Update | 161 |
| USB memory device | 20 |
| User calibration | 50, 88 |
| User-defined methods | |
| Concentration | 57 |
| Multi wavelengths | 72 |

Z

| | |
|-----------------------|----|
| Zero adjustment | 34 |
|-----------------------|----|

Xylem |'zīləm|

- 1) The tissue in plants that brings water upward from the roots;
- 2) a leading global water technology company.

We're a global team unified in a common purpose: creating advanced technology solutions to the world's water challenges. Developing new technologies that will improve the way water is used, conserved, and re-used in the future is central to our work. Our products and services move, treat, analyze, monitor and return water to the environment, in public utility, industrial, residential and commercial building services settings. Xylem also provides a leading portfolio of smart metering, network technologies and advanced analytics solutions for water, electric and gas utilities. In more than 150 countries, we have strong, long-standing relationships with customers who know us for our powerful combination of leading product brands and applications expertise with a strong focus on developing comprehensive, sustainable solutions.

For more information on how Xylem can help you, go to www.xylem.com.



Service and Returns:

Xylem Analytics Germany
Sales GmbH & Co. KG
WTW
Am Achalaich 11
82362 Weilheim
Germany

Tel.: +49 881 183-325
Fax: +49 881 183-414
E-Mail wtw.rma@xylem.com
Internet: www.xylemanalytics.com



Xylem Analytics Germany GmbH
Am Achalaich 11
82362 Weilheim
Germany

