

## Compressor-cooled incubator ICP450

Ideal for ramp operation with rapid temperature changes during incubation, breeding or storage.

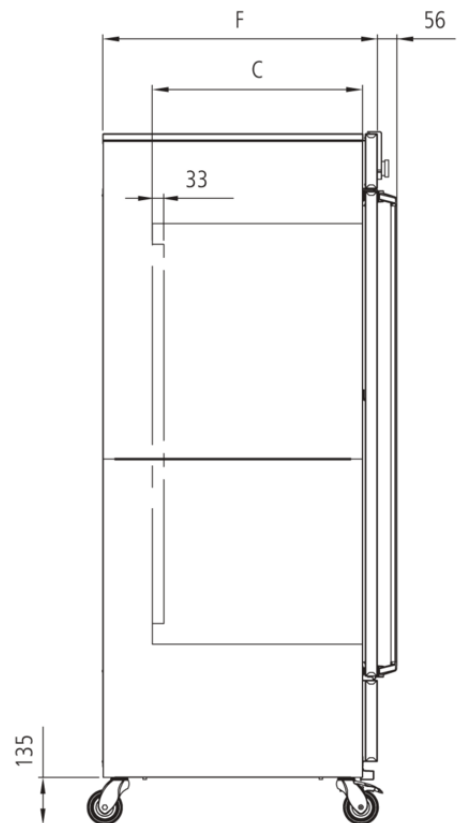

With the help of our model selection, with dimensioned model sketches and extensive technical data for download, you can find the right cooled incubator ICP for your needs. For small volumes and for work predominantly in the proximity of the ambient temperature, the Memmert Peltier-cooled incubator is recommended. Flexibility and technical features of our appliances meet all possible needs. Put us to the test!

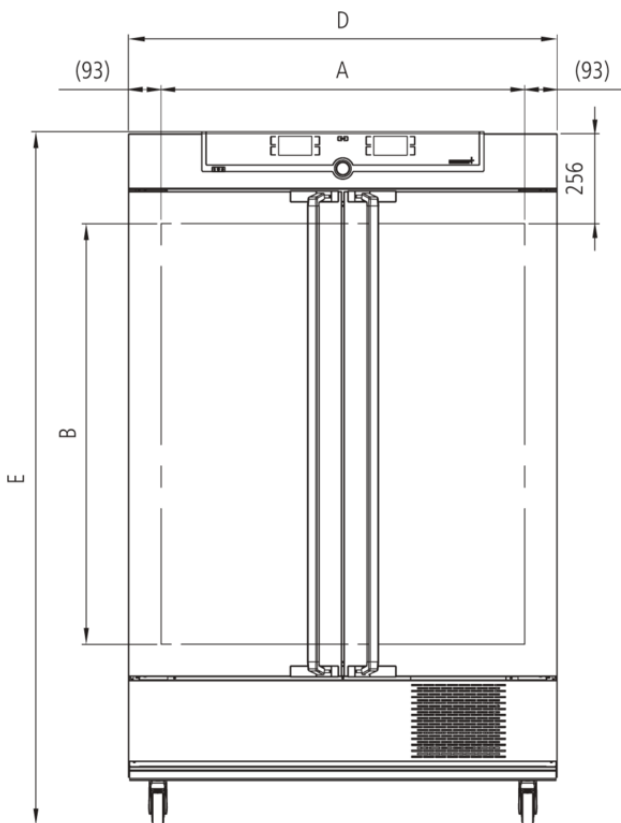

## Temperature

<b>Setting temperature range</b>	-12 to +60 °C
<b>Working-temperature range</b>	from -12°C up to +60°C (Optimum performance of cooling aggregate at an ambient temperature of +16°C up to +34°C. Not suitable for long-term storing at sub-zero temperatures. During permanent operation, the glass door may ice over.)
<b>Setting accuracy temperature</b>	0.1 °C
<b>Temperature sensor</b>	2 Pt100 sensors DIN Class A in 4-wire-circuit for mutual monitoring, taking over functions in case of an error

## Control technology

<b>ControlCOCKPIT</b>	TwinDISPLAY. Adaptive multifunctional digital PID-microprocessor controller with 2 high-definition TFT-colour displays.
<b>Language setting</b>	German, English, Spanish, French, Polish, Czech, Hungarian
<b>Timer</b>	Digital backwards counter with target time setting, adjustable from 1 minute to 99 days
<b>Function SetpointWAIT</b>	the process time does not start until the set temperature is reached
<b>Calibration</b>	three freely selectable temperature values
<b>adjustable parameters</b>	temperature (Celsius or Fahrenheit), fan speed, programme time, time zones, summertime/wintertime

## Communication

<b>Documentation</b>	programme stored in case of power failure
<b>Programming</b>	AtmoCONTROL software on a USB stick for programming, managing and transferring programmes via Ethernet interface or USB port

## Safety

<b>Temperature control</b>	mechanical temperature limiter TB, protection class 1 according to DIN 12880 to switch off the heating approx. 10°C above nominal temperature
<b>Temperature control</b>	over- and undertemperature monitor TWW, protection class 3.3 or adjustable temperature limiter TWB, protection class 2, selectable on display
<b>AutoSAFETY</b>	additionally integrated over- and undertemperature protection "ASF", automatically following the setpoint value at a preset tolerance range, alarm in case of over- or undertemperature, heating is switched off in case of overtemperature, compressor in case of undertemperature
<b>Autodiagnostic system</b>	for fault analysis
<b>Alarm</b>	visual and acoustic

## Heating concept

<b>Air jacket</b>	air jacket heating system for gentle all-around heating
<b>Heating concept</b>	no drying-up of the load caused by the cooling device due to separation of thermal jacket from interior
<b>Cooling</b>	energy-saving use of CFC-free cooling/heating system (refrigerant R134a)
<b>Defrosting</b>	highly efficient automatic defrosting system

## Standard equipment

<b>Internals</b>	2 stainless steel grid(s), electropolished
<b>Works calibration certificate</b>	for +10°C and +37°C
<b>Door</b>	inner glass doors
<b>Door</b>	fully insulated stainless steel doors with 2-point locking (compression door lock)

## Stainless steel interior

<b>Dimensions</b>	$w_{(A)} \times h_{(B)} \times d_{(C)}$ : 1040 x 720 x 600 mm (d less 33 mm for fan)
<b>Volume</b>	449 l
<b>Max. number of internals</b>	8
<b>Max. loading of chamber</b>	200 kg
<b>Max. loading per internal</b>	30 kg

## Textured stainless steel casing

<b>Dimensions</b>	$w_{(D)} \times h_{(E)} \times d_{(F)}$ : 1224 x 1467 x 784 mm (d +56mm door handle)
<b>Installation</b>	on lockable castors
<b>Housing</b>	rear zinc-plated steel

## Electrical data

<b>Voltage</b>	230 V, 50 Hz
<b>Electrical load</b>	approx. 1200 W
<b>Voltage</b>	115 V, 50/60 Hz
<b>Electrical load</b>	approx. 1200 W

## Ambient conditions

<b>Set Up</b>	The distance between the wall and the rear of the appliance must be at least 15 cm. The clearance from the ceiling must not be less than 20 cm and the side clearance from walls or nearby appliances must not be less than 5 cm.
<b>Ambient temperature</b>	15 °C to 28 °C (up to 34 °C with limited temperaturerange)
<b>Humidity rh</b>	max. 70 %, non-condensing
<b>Altitude of installation</b>	max. 2,000 m above sea level
<b>Overvoltage category</b>	II
<b>Pollution degree</b>	2

### Packing/shipping data

<b>Transport information</b>	The appliances must be transported upright
<b>Customs tariff number</b>	8419 8998
<b>Country of origin</b>	Federal Republic of Germany
<b>WEEE-Reg.-No.</b>	DE 66812464
<b>Dimensions approx incl. carton</b>	w x h x d: 1330 x 1700 x 1050 mm
<b>Net weight</b>	approx. 217 kg
<b>Gross weight carton</b>	approx. 282 kg

**Standard units are safety-approved and bear the test marks**

